



FOREWORD

Thank you for purchasing our Ride on lawnmower. We are confident it will give you many years of reliable Service.

The introduction in this manual sets out the correct manner of operating, maintaining and checking the Ride on lawnmower to ensure long-term durability.

Please ensure correct operation of the Ride on lawnmower as incorrect operation can cause substantial mechanical damage as well as cause accidents with the associated injuries.

Please note that in some cases differences can exist between this manual and your Ride on lawnmower due to the manufacture's policy of constant product improvement.

In the event that you encounter a problem not covered by this manual please contact your nearest dealer who will assist you in resolving your problem.



WARNING





CALIFORNIA Proposition 65 Warning

The Engine Exhaust from this product contains chemicals known to the state of California to cause cancer, birth defects or other reproductive harm.



WARNING SIGNS IN THIS MANUAL

The following warning signs in this manual draw additional attention to items of importance for the safe and correct operation of the Ride on lawnmower.

SIGN	MEANING OF THE SIGN
 DANGER	This indicates that a condition may result in harm, serious injury or death to you or other persons if the warning is not heeded. Follow the advice provided with the warning.
 WARNING	Hazard or unsafe practice that can lead to severe injury or death.
 CAUTION	Hazard or unsafe practice that can lead in injury or death.
 IMPORTANT	Instructions for the correct operation of the machine which, if followed, will ensure that it performs at it's best.

All information, illustrations and specifications in this manual are based on latest information available at the time of publication. The right is reserved to make changes at any time without notice.



SAFETY PRECAUTIONS



1. RIDE ON LAWNMOWER IDENTIFICATION

The engine number is stamped on the left hand side of the engine block.

The chassis number is shown on the left hand side of the Ride on lawnmower as shown in the drawing.



TK0003A

WARRANTY OF THE PRODUCT

The manufacturer warrants this product and full details of the warranty are provided on a separate warranty schedule.

SERVICE

Service is available from any **TYM** dealer in the country.

PARTS

To obtain spare parts please contact your nearest dealer and give him the details listed below.

- Ride on lawnmower model
- Ride on lawnmower serial number
- Ride on lawnmower engine number
- Part number and description
- Quantity required

 - 3



SAFETY PRECAUTIONS

2. ABOUT THIS MANUAL

This manual has been prepared to assist you in following/adopting the correct procedure for running-in operation and maintenance of your new **Tong Yang Moolsan CO., LTD** (Here in after refer to **TYM**) Ride on lawnmower.

Your Ride on lawnmower has been designed and built to give maximum performance, with good fuel economy and ease of operation under a wide variety of operating conditions. Prior to delivery, the Ride on lawnmower was carefully inspected, both at the factory and by your **TYM** Dealer/Distributor, to ensure that it reaches you in optimum condition. To maintain this condition and ensure trouble free performance. it is important that the routine services, as specified in this manual, are carried out at the recommended intervals.

Read this Manual carefully and keep it in a convenient place for future reference. If at any time you require advice concerning your Ride on lawnmower, do not hesitate to contact your Authorized **TYM** dealer/Distributor. He has trained personnel, genuine parts and necessary equipments to undertake all your service requirements.

Manufacturer's policy is one of continuous improvement, and the right to change prices, specifications or equipments at any time without notice is reserved.

All data given in this book is subject to production variations. Dimensions & weight are approximate only and the illustrations do not necessarily show Ride on lawnmowers in standard condition. For exact information about any particular Ride on lawnmower, please consult your **TYM** dealer/Distributor.



SAFETY PRECAUTIONS

3. DESCRIPTION

DESCRIPTION

▶ GENERAL CONSTRUCTION

The transmission case, Engine and Front Axle Support are bolted together to form a rigid unit.

▶ FRONT AXLE & WHEELS

The 4WD front axle is a center-pivot, reverse Eliot type. The front wheel drive mechanism is incorporated as a part of the axle.

The front wheel drive power is taken off the rear transmission and transmitted to the differential in the front axle where the power is divided into right and left and to the respective final cases.

In the final cases, the transmitted revolution is reduced by the level gears to drive the front wheel. The 4WD mechanism with level gears provides wider steering and greater durability.

▶ ENGINE

The Ride on lawnmower are fitted with vertical, Water-cooled 3-cycle and spherical chamber type YANMAR ENGINE(3TNV74F-SDKTF2)

▶ TRANSMISSION WITH HST (HYDROSTATIC TRANSMISSION)

The Ride on lawnmower is fitted HST with 2 Range and can be selected Speed range by HIGH-LOW selector lever.

The Ride on lawnmower has Two pedals for forward/reverse control . Ride on lawnmower with Independent Power Take Off is fitted with electro-hydraulic Clutch Assy. The Mid PTO can be operated both or separately by a lever.

TYM Ride on lawnmower are provided with independent disc brakes operated by two road travel. A foot brake lever is fitted for parking.

▶ REAR AXLE & WHEELS

This is mounted on ball bearings and is enclosed in removable housing which are bolted to the transmission case. The rim & Disc fitted with Rear tires are bolted to the outer flange of Rear Axle.

▶ HYDRAULIC SYSTEM & LINKAGES

TYM Ride on lawnmower are fitted with Live (i.e. system is in operation) independent, very touch of hydraulic System.

▶ STEERING

It consists of Hydrostatic Power steering system, which has a hydraulic cylinder and tandem type hydraulic pump.



SAFETY PRECAUTIONS

▶ ELECTRICAL SYSTEM

A 12 Volt Lead Acid Propylene Battery is used to activate the Engine through the Starter Motor and the Electrical system comprising Horn, Head Lamp. Side indicator Lamps, Plough Lamp, Brake Light, Gauge lamp, Hazard Lamp. Generator or Alternator, Fuse box also from part of the Electrical system.

WARNING

- When operating the Ride on lawnmower at High speed, Do not attempt to make sharp turns by using the brakes. This may result in overturning of the Ride on lawnmower causing serious injury or DEATH.

4. OWNER ASSISTANCE

We at **TYM CO.,LTD** and your **TYM** Dealer/Distributor wants you to be completely satisfied with your investment. Normally any problems with your equipment will be handled by your Dealer/Distributor's Service Departments, however, misunderstanding can occur. If you feel that your problem has not been handled to your satisfaction, we suggest the following.

Contact the owner or General Manager of the Dealership, explain the problem, and request assistance. When additional assistance is needed, Your Dealer/Distributor has direct access to your office. If you cannot obtain satisfaction by doing this, contact the **TYM CO.,LTD**. Office and provide them with;

- Your name, address and telephone number
- Model and Ride on lawnmower serial number
- Dealer/Distributor Name & Address
- Machine purchase date and Hours used
- Nature of problem

Before contacting TYM CO.,LTD office, be aware that your problem will likely to be resolved in the Dealership using the Dealer's/Distributor's facilities, equipment and personnel. So it is important that your initial contact be with the Dealer/Distributor.



SAFETY PRECAUTIONS

5. ROPS (ROLL OVER PROTECTIVE STRUCTURES)

ROLL OVER PROTECTIVE STRUCTURES (ROPS)

TYM Ride on lawnmower are equipped with a frame for the protection of operators.

In the case of cab Ride on lawnmower the frame is incorporated in the cab structure.

The objective of the frame or cab structure is to protect the operator in the event of a roll over

and they are designed to support the entire weight of the Ride on lawnmower in that event.

Each **TYM** ROPS frame or cab structure is designed and has been tested to meet industry and or government standards.

Included in these tests were all mounting bases and bolts or other fasteners.

DANGER

- For ROPS frames to be effective and protect the operator, the seat belt provided must be worn in order to keep operators within the ROPS protected area in the event of a roll over. Failure to use the seat belt can still cause serious injury or death.

On some models the ROPS frame has a fold down feature, which can be used to enter low buildings etc. Take care when lowering the upper section of the ROPS frame and take extreme care while driving the Ride on lawnmower with the ROPS frame lowered. Do not wear the seat belt with the ROPS lowered and please remember that the fold down facility is for special circumstances only and must not be lowered for general use.

USE OF THE RIDE ON LAWNMOWER WITH THE ROPS LOWERED CAN CAUSE FATAL INJURIES

As the ROPS frame or cab together with the seat belt was designed to meet certain standards, they must be maintained in good order and condition. To achieve this objective, both the structure and the seat belt should be inspected on a regular basis. (Every time the Ride on lawnmower is serviced)

In the event that the seat belt is damaged or frayed, it should be replaced and in the event that the ROPS frame or any part of the mounting structure is damaged or cracked, the faulty component must be replaced with a new unit. Such a unit must meet all of the test criteria of the original unit. Fitment of an inferior item or items affects the certification of the entire ROPS structure and the effectiveness of the structure in the event of an accident. Drilling or welding of the ROPS structure is forbidden.



SAFETY PRECAUTIONS

DAMAGE OF THE ROPS



If the Ride on lawnmower has rolled over or the ROPS has been damaged (such as striking an overhead object during transport), It must be replaced to provide the original protection. After an accident, check for damages to the 1.ROPS. 2.Seat. 3.seat belt & seat mountings. Before you operate a Ride on lawnmower, replace all damaged parts.

WARNING

- Do not weld, drill or straighten the ROPS.

 - 8

WARNING

- Never attach chains or ropes to the ROPS for pulling purposes; this will cause the Ride on lawnmower to tip backwards. Always pull from the Ride on lawnmower drawbar. Be careful when driving through door opening or under low overhead objects. Make sure there is sufficient overhead clearance for the ROPS fatal injuries.

WARNING

- If the ROPS is removed or replaced, make certain that the proper hardware is used to replace the ROPS and the recommended torque values are applied to the attaching bolts.

WARNING

- Always wear your seat belt if the Ride on lawnmower is equipped with ROPS.

SEAT SLIDING



Before operating a Ride on lawnmower it is important to adjust the seat to the most comfortable position & check whether it is properly locked in its position.

NOTE

- Do not use solvents to clean the seat. Use warm water with a little detergent added.

CAUTION

- Do not put a hand between the seat and the slides when adjusting the seat position. You can get injured unexpectedly.



SAFETY PRECAUTIONS

6. SAFETY INSTRUCTIONS

To select Seat position, move Adjusting lever and slide Seat closer to or away from Dash panel and controls.

DANGER

- Check whether the seat properly locked in its position before driving the Ride on lawnmower.

DANGER

- Always use the seat belt when the ROPS is installed. Do not use the seat belt if a foldable ROPS is down or there is no ROPS. Check the seat belt regularly and replace if frayed or damaged.

RECOGNIZE SAFETY INFORMATION

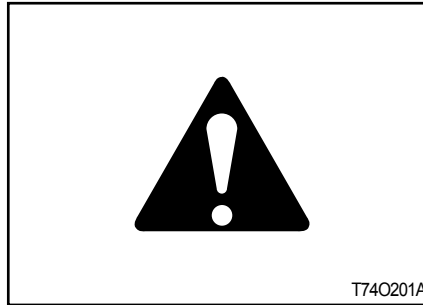

This symbol means ATTENTION! YOUR SAFETY IS INVOLVED. The message that follows the symbol contains important information about safety. Carefully read the message.

SIGNAL WORDS



A signal word "DANGER, WARNING OR CAUTION" is used with safety alert symbol. DANGER identifies the most serious hazards. Safety signs with signal Word "DANGER OR WARNING" are typically near specific hazards. General precautions are listed on CAUTION safety signs.

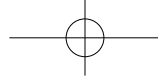

SAFETY PRECAUTIONS

READ SAFETY INSTRUCTION

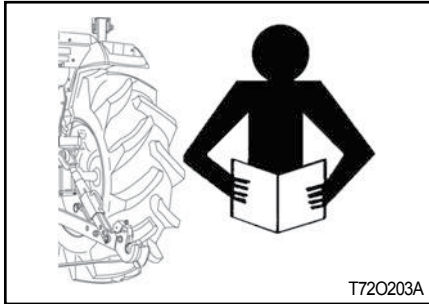

Carefully read all safety instructions given in this manual for your safety. Tempering with any of the safety devices can cause serious injuries or death. Keep all safety signs in good condition. Replace missing or damaged safety signs.

Keep your Ride on lawnmower in proper condition and do not allow any unauthorized modifications to be carried out on the Ride on lawnmower, which may impair the function/safety and affect Ride on lawnmower life.

 - 10

PROTECTION CHILDREN

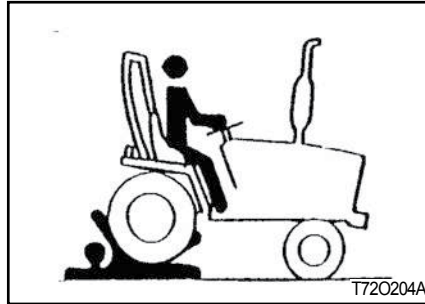

Keep children and others away from the Ride on lawnmower while operating.

BEFORE YOU REVERSE:

- Look behind Ride on lawnmower for children.
- Do not let children to ride on Ride on lawnmower or any implement.

USE OF ROPS AND SEAT BELT

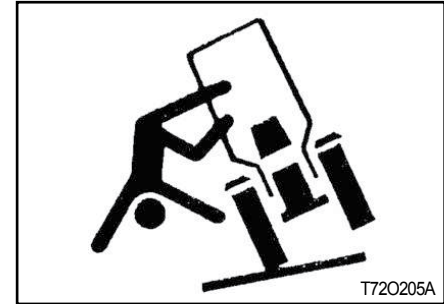

The Roll Over Protective Structure (ROPS) has been certified to industry and/or government standards. Any damage or alternation to the ROPS, mounting hardware, or seat belt voids the certification and will reduce or eliminate protection for the operator in the event of a roll-over. The ROPS, mounting hardware, and seat belt should be checked after the first 100 hours of Ride on lawnmower and every 500



SAFETY PRECAUTIONS

hours thereafter for any evidence of damage, wear or cracks. In the event of damage or alteration, the ROPS must be replaced prior to further operation of the Ride on lawnmower.

The seat belt must be worn during machine operation when the machine is equipped with a certified ROPS.

Failure to do so will reduce or eliminate protection for the operator in the event of a roll over.

PRECAUTION TO AVOID TIPPING

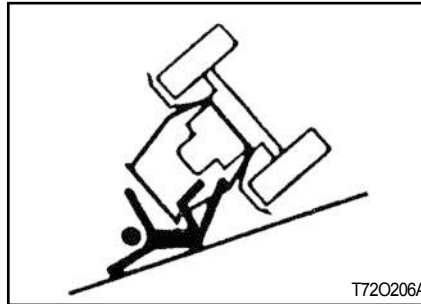

Do not drive where the Ride on lawnmower could slip or tip.

Stay alert for holes and rocks in the terrain, and other hidden hazards.

Slow down before you make a sharp turn.

Driving forward out of a ditch or mired condition could cause Ride on lawnmower to tip over backward. Back out of these situations if possible.

PARK RIDE ON LAWNMOWER SAFELY

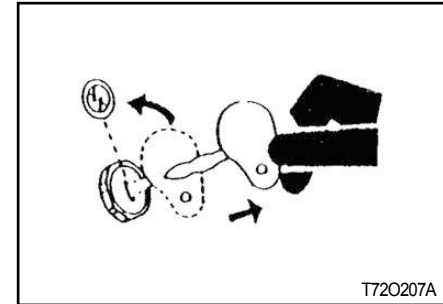

Before working on the Ride on lawnmower;

Lower all equipment to the ground.

Stop the engine and remove the key.



SAFETY PRECAUTIONS

KEEP RIDERS OFF RIDE ON LAWNMOWER

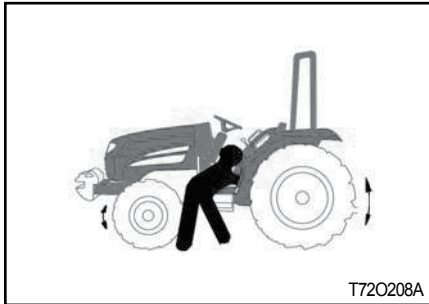

Do not allow riders on the Ride on lawnmower.

Riders on Ride on lawnmower are subject to injury such as being stuck by foreign objects and being thrown off of the Ride on lawnmower.

HANDLE FUEL SAFELY AVOID FIRES

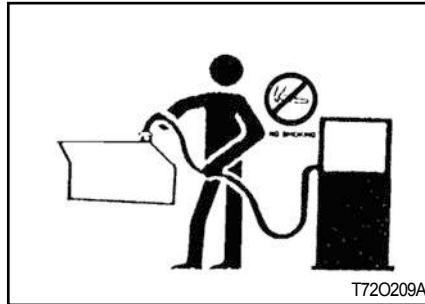

Handle fuel with care; it is highly flammable. Do not refuel the Ride on lawnmower while smoking or near open flame or sparks.

Always stop engine before refueling Ride on lawnmowers.

Always keep your Ride on lawnmower clean of accumulated grease, and debris. Always clean up spilled fuel.

STAY CLEAR OF ROTATING SHAFTS



Entanglement in rotating shaft can cause serious injury or death.

Keep PTO shield in place at all times.

Wear close fitting clothing. Stop the engine and be sure PTO drive is stopped before making adjustments, connections, or cleaning out PTO driven equipment.



SAFETY PRECAUTIONS

ALWAYS USE SAFETY LIGHTS AND DEVICES

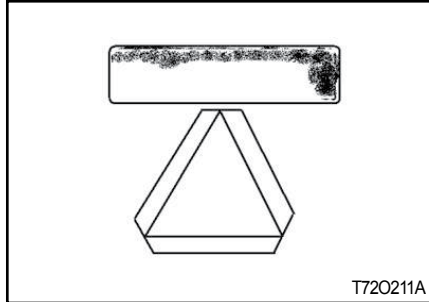

Use of hazard warning lights and turn signals are recommended when towing equipment on public roads unless prohibited by state or local regulations.

Use slow moving vehicle (SMV) sign when driving on public road during both day & night time, unless prohibited by law.

PRACTICE SAFE MAINTENANCE



Understand service procedure before doing work.

Keep the surrounding area of the Ride on lawnmower clean and dry.

Do not attempt to service Ride on lawnmower when it is in motion.

Keep body and clothing away from rotating shafts.

Always lower equipment to the ground. Stop the engine.

Remove the key. Allow Ride on lawnmower to cool before any work repair is caused on it.

Securely support any Ride on lawnmower elements that must be raised for service work.

Keep all parts in good condition and properly installed.

Replace worn or broken parts. Replace damage/missing decals.

Remove any buildup of grease or oil from the Ride on lawnmower.

Disconnect battery ground cable(-) before making adjustments on electrical systems or welding on Ride on lawnmower.

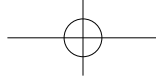

SAFETY PRECAUTIONS

AVOID HIGH-PRESSURE FLUIDS



Escaping fluid under pressure can penetrate the skin causing serious injury. Keep hands and body away from pinholes and nozzles, which eject fluids under high pressure. If any fluid is injected into the skin. Consult your doctor immediately.

PREVENT BATTERY EXPLOSIONS



Keep sparks, lighted matches, and open flame away from the top of battery. Battery gas can explode. Never check battery charge by placing a metal object across the terminals.

PREVENT ACID BURNS

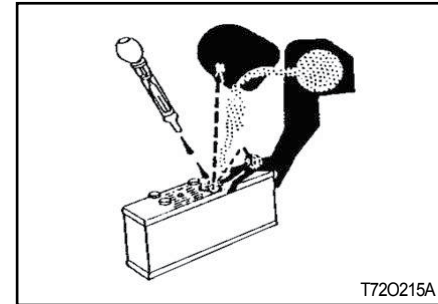

Sulfuric acid in battery electrolyte is poisonous. It is strong enough to burn skin, cause holes in clothing and cause blindness if found entry into eyes.

For adequate safety always;

1. Fill batteries in a well-ventilated area.
2. Wear eye protection and acid proof hand gloves.
3. Avoid breathing direct fumes when electrolyte is added.
4. Do not add water to electrolyte as it may splash off causing severe burns.



SAFETY PRECAUTIONS

If you spill acid on yourself;

1. Flush your skin with water.
2. Flush your eyes with water for 10-15 minutes.

Get medical attention immediately.

BATTERY DISCONNECT

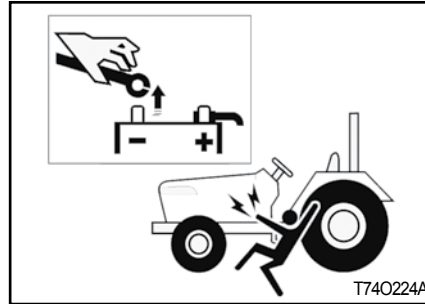

1. When working with your Ride on lawnmowers electrical components you must first disconnect the battery cables.
2. To ensure that there are no accidents from sparks you must first disconnect the negative battery cable.

SERVICE RIDE ON LAWN-MOWER SAFELY

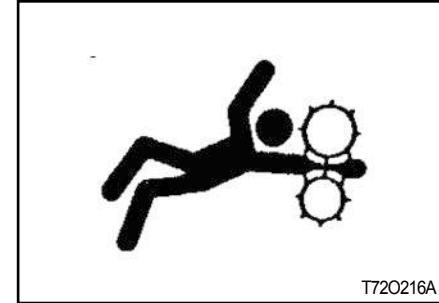

Do not wear a necktie, scarf or loose clothing when you work near moving parts. If these items were to get caught, severe injury could result.

Remove rings and other jewelry to prevent electrical shorts and entanglement in moving parts.



SAFETY PRECAUTIONS

WORK IN VENTILATED AREA

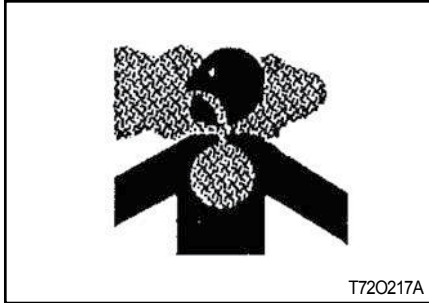

Do not start the Ride on lawnmower in an enclosed building unless the doors & windows are open for proper ventilation, as Ride on lawnmower fumes can cause sickness or death. If it is necessary to run an engine in an enclosed area remove the exhaust fumes by connecting exhaust pipe extension.

RIDE ON LAWNMOWER RUN-AWAY

1. The Ride on lawnmower can start even if the transmission is engaged position causing Ride on lawnmower to runaway and serious injury to the people standing nearby the Ride on lawnmower.
2. For additional safety keep the pull to stop knob (Fuel shut off control) in fully pulled out position.

Transmission in neutral position, Foot brake engaged and PTO lever in disengaged position while attending to Safety Starter Switch or any other work on Ride on lawnmower.

SAFETY STARTER SWITCH

1. Brake operated safety switch is provided on all Ride on lawnmowers which allow the starting system to become operational only when the Brake pedal is fully pressed.
2. Do not by-pass this safety starter switch or work on it. Only Authorized Dealers are recommended to work on safety starter switch.
3. On some models Safety Starter switch is provided on transmission High-low shifter lever and in PTO shifter lever. The Ride on lawnmower can be started only if High-low shifter lever is in neutral position.

CAUTION

- Safety Starter Switch is to be replaced after every 2.000 hours/4 years, whichever is earlier.

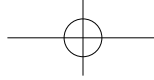

SAFETY PRECAUTIONS

SAFE OPERATION OF YOUR RIDE ON LAWNMOWER

The manufacturer of your Ride on lawnmower has made every effort to make it as safe as is humanly possible.

Beyond this point it is the responsibility of the operator to avoid accidents and we ask that you read and implement our suggestions for your safety.

Ensure that only trained and competent operators use this Ride on lawnmower and ensure that they are fully conversant with the machine and aware of all its control and safety features.

Operators should not operate the Ride on lawnmower or associated machinery while tired or untrained.

To avoid accidents please ensure that the operator wears clothing which will not get entangled in the moving parts of the Ride on lawnmower or machine and protect him or her from the elements.

When spraying or using chemicals, please ensure that clothing and protective equipment is worn which prevents respiratory or skin problems.

For full details consult the manufacturer of the chemicals.

To avoid lengthy exposure to noise ensure that ear protection is worn.

If adjustment to the Ride on lawnmower or machinery need to be made ensure the Ride on lawnmower or machine are turned off beforehand.

Use of certified Roll Over Protection Structure (ROPS) is a must while operating a Ride on lawnmower.

Use of seat belt is a must while operating a Ride on lawnmower.

In summary, ensure at all times that the safety of the operator and any other worker is paramount.

Ensure no one is between the Ride on lawnmower and a towed vehicle (trailer or implement).

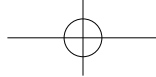

SAFETY PRECAUTIONS

SAFETY TIPS DURING MAINTENANCE

1. At least on a daily basis check all oil levels. Water level in the radiator and electrolyte level in the battery and perform services according to the service schedule.
2. Ensure tire pressure are even and the correct pressure for the job being done is maintained.
3. Check to ensure that the all controls and preventative mechanisms of the Ride on lawnmower and implement work correctly and effectively.
4. Ensure that an adequate set of the correct tools is available for maintenance and minor repairs.
5. Ensure that all service work and repairs are carried out on a flat area with a concrete or similar floor.

Do not carry out service work on a Ride on lawnmower until it is switched off, and the parking brake applied and wheels chocked.

Where a Ride on lawnmower is started in a confined area, ensure that the area is well ventilated as exhaust gases are very harmful, and can cause death.

6. Do not work under raised implements.
7. When changing wheels or tires ensure that a suitable wheel stand is placed under the axle prior to removing the wheel and the wheels are chocked.
8. Where guards or shields need to be removed to perform a service or repair, ensure that the guard or shield is correctly reinstalled before starting the Ride on lawnmower.

9. Never refuel near a naked flame or with an overheated engine. Ensure to turn off Engine before refueling.

10. The cooling system operates under pressure, take care when removing the radiator cap on a hot engine to prevent being scalded by steam or hot water. Do not add water in the radiator when the engine is hot. Add water to the radiator only after the engine cools down completely.

11. To prevent fires keep the Ride on lawnmower including the engine clean and free from inflammable material and well away from fuels and other inflammable material.



SAFETY PRECAUTIONS

MOUNTING AND REMOVING IMPLEMENTS

1. Ensure that all mounting and removal of implements is done on safe flat ground. Ensure no one is between the Ride on lawnmower and implement and do not get under the implement to avoid accidental injuries.
2. After mounting the implement, ensure that all stabilizers are correctly adjusted and, where PTO shafts are used that the shaft is fitted and secured correctly.
3. Where heavy implements are used, ensure that the combination is well balanced or use proper ballast to achieve balance.
4. Before leaving the Ride on lawnmower at any time, lower the implement, stop the PTO shaft where applicable, set the parking brake and switch off the engine.
5. While operating the implements with the PTO keep all bystanders away from any moving parts and do not attempt to make adjustments while the machine is running.
6. Only the driver should ride on the Ride on lawnmower with the ROPS frame fitted and with the seat belt properly fastened.
7. Where young children are present, particular care should be taken and the Ride on lawnmower should not be moved until the whereabouts of all children is known.
8. Only trained operators should operate the Ride on lawnmower and so taking care to ensure that other workers are not injured. In particular they should take care during dusty operations, which will reduce visibility substantially.
9. Never start the Ride on lawnmower unless the transmission is out of gear, the operator is in the seat and all round safety has been checked.
10. Only operate the Ride on lawnmower seated in the drivers seat and never turn or brake suddenly at high speed as this can cause a roll-over and serious injury or death.
11. When traveling on a public road ensure that the Ride on lawnmower and driver both meet all laws relating to safety and licensing. When traveling with wide implements use red flags on the extremities and observe all legal including escort requirements.
12. When operating under adverse conditions, hilly terrain or on bad ground adjust the speed of the Ride on lawnmower to suit the conditions, safety comes first. Never drive down hill at high speed or with the transmission in neutral. Use of the braking capacity of the engine as well as the service brakes.



SAFETY PRECAUTIONS

Do not try to change gear going up or down a steep slope, select the correct gear before starting.

13. Take care when traveling uphill with a heavy implement to ensure that it does not overbalance and tip up the front end.
14. Never remove or modify the seat belt.
15. Never remove, modify or repair the ROPS frame.

Please remember that a little bit of extra care can prevent serious injury or death and avoid damage to your Ride on lawnmower.

▶ THE FOLLOWING PRECAUTIONS ARE SUGGESTED TO HELP PREVENT ACCIDENTS

A careful operator is the best operator. Most accidents can be avoided by observing certain precautions. Read and take the following precautions before operating the Ride on lawnmower to prevent accidents.

Ride on lawnmower should be operated only by those who are responsible and properly trained to do so.

<THE RIDE ON LAWNMOWER>

1. Read the operator's manual carefully before using the Ride on lawnmower. Lack of operating knowledge can lead to accidents.
2. Use an approved rollover bar and seat belt for safe operation. Overturning of a Ride on lawnmower without a rollover bar can result in death or injury.
3. Do not remove ROPS (Roll Over Protective Structure). Always use the seat belt.

4. Fiberglass canopy does not give any protection.
5. To prevent falls, keep steps and platform clear of mud and oil.
6. Do not permit anyone but the operator to ride on the Ride on lawnmower. There is no safety place for extra riders.
7. Replace all missing, illegible or damaged safety signs.
8. Keep safety signs clean of dirt and grease.

<SERVICING THE RIDE ON LAWNMOWER>

1. keep the Ride on lawnmower in good operating condition for your safety. An improperly maintained Ride on lawnmower can be hazardous.
2. Stop the engine before performing any service on the Ride on lawnmower.
3. The cooling system operates under pressure, which is controlled



SAFETY PRECAUTIONS

by the radiator cap. It is dangerous to remove the cap while the system is hot. First turn the cap slowly to stop and allow the pressure to escape before removing the cap entirely.

4. Do not smoke while the refueling the Ride on lawnmower. Keep away any type of open flame.
5. The fuel in the injection system is under high pressure and can penetrate the skin. Unqualified persons should not remove or attempt to adjust a pump, injector, nozzle or any part of the fuel injection system.

Failure to follow these instructions can result in serious injury.

6. Keep open flame away from battery or cold weather starting aids to prevent fire or explosions.
7. Do not modify or alter or permit anyone else to modify or alter this Ride on lawnmower or any of its components or any Ride on lawnmower functions.

<OPERATING THE RIDE ON LAWNMOWER>

1. Before starting the Ride on lawnmower apply the parking brake, place the PTO (Power Take Off) lever in the "OFF" position, the hydraulic control levers in the downward position, the remote control valve levers in the neutral position (If fitted) and the transmission in neutral.
2. Do not start the engine or controls while standing besides the Ride on lawnmower. Always sit on the Ride on lawnmower seat when the engine or operating controls.
3. Safety starter switch.

In order to prevent the accidental starting of the Ride on lawnmower, a safety switch has been provided. The starting system of the Ride on lawnmower is connected through this switch, which becomes operative only when the brake pedal is depressed. On

some models shuttle shifter lever and PTO button should also be in neutral position for completing the starting circuit. Do not bypass the safety starter switch. Consult your **TYM** Ride on lawnmower Dealer/Distributor if safety-starting switch malfunctions.

4. Avoid accidental contact with the gear shifter lever while the engine is running. Unexpected Ride on lawnmower movement can result from such contact.
5. Do not get off or climb the Ride on lawnmower while it is in motion.
6. Shut off the engine, remove the key and apply the parking brake before getting off the Ride on lawnmower.
7. Do not operate the Ride on lawnmower in an enclosed building without adequate ventilation. Exhaust fumes can cause death.
8. Do not park the Ride on lawnmower on a steep slope.

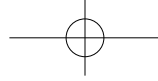

SAFETY PRECAUTIONS

9. If power steering or Engine ceases to operate, stop the Ride on lawnmower immediately.
10. Pull only from the draw bar or the lower link drawbar in the down position. Use only a drawbar pin that locks in place. Pulling from the Ride on lawnmower rear axle carriers or any point above the rear axle may cause the Ride on lawnmower front end to lift.
11. If the front end of the Ride on lawnmower tends to rise when heavy implements are attached to the three-point linkage, install front end or front wheel weights. Do not operate the Ride on lawnmower with a light front end.
12. Always use hydraulic position control lever when attaching equipments/implement and when transporting equipment. Be sure that the hydraulic couplers are properly mounted and will disconnect safely in case of accidental detachment of implement.

13. Do not leave equipment/implement in the raised position.
14. Use the flasher/ Turn signal lights and Slow Moving Vehicle (SMV) signs when driving on public roads during both day and night time, unless prohibited by law.
15. Dim Ride on lawnmower lights when meeting a vehicle at night. Be sure the lights are adjusted to prevent the blinding on the eyes of coming vehicle operator.

<DRIVING THE RIDE ON LAWN-MOWER>

1. Watch where you are going especially at row ends, on roads, around trees and low hanging obstacles.
2. To avoid upsets, drive the Ride on lawnmower with care and at speeds compatible with safety, especially when operating over rough ground, crossing ditches or slopes, and when turning at corners.

3. Lock the Ride on lawnmower brake pedals together when transporting on roads to provide proper wheel braking.
4. Keep the Ride on lawnmower in the same gear when going downhill as used when going uphill. Do not coast or free wheel down hills.
5. Any towed vehicle and/or trailer whose total weight exceeds that of the towing Ride on lawnmower, must be equipped with its own brakes for safe operation.
6. When the Ride on lawnmower is stuck or tires are frozen to the ground, back out to prevent upset.
7. Always check overhead clearance, especially when transporting the Ride on lawnmower.



SAFETY PRECAUTIONS



<OPERATING THE PTO>

1. When operating PTO driven equipment, shut off the engine and wait until the PTO stops before getting off the Ride on lawnmower and disconnecting the equipment.
2. Do not wear loose clothing when operating the power take-off or near rotating equipment.
3. When operating stationary PTO driven equipment, always apply the Ride on lawnmower parking brake and block the rear wheels from front and rear side.
4. To avoid injury, always move down flip part of PTO. Do not clean, adjust or service PTO driven equipment when the Ride on lawnmower engine is running.
5. Make sure the PTO master shield is installed at all times and always replace the PTO shield cap when the PTO is not in use.

<DIESEL FUEL>

1. Keep the equipment clean and properly maintained.
2. Under no circumstances should gasoline, alcohol or blended fuels be added to diesel fire or explosive hazard. Such blends are more explosive than pure gasoline. In a closed container, such as a fuel tank. **DO NOT USE THESE BLENDS.**
3. Never remove the fuel cap or refuel the Ride on lawnmower with the engine running.
4. Do not smoke while refueling or when standing near fuel.
5. Maintain control of the fuel filler pipe when filling the tank.
6. Do not fill the fuel tank to capacity. Allow room for expansion.
7. Wipe up spilled fuel immediately.
8. Always tighten the fuel cap securely.

9. If the original fuel tank cap is lost, replace it with genuine cap. A non approved cap may not be safe.
10. Do not drive equipment near open fire.
11. Never use fuel for cleaning purpose.
12. Arrange fuel purchases so that winter grade fuel are not held over and used in the spring.
13. USE ultra low sulfur fuel only.

※N.B: It is suggested that after repairs if any of the Safety Decal/sign is peeled/defaced, the same should be replaced immediately in interest of your safety.



SAFETY PRECAUTIONS

7. DO'S AND DON'T'S

DO'S-FOR BETTER PERFORMANCE

- DO** - Ensure that safety shields are in place and in good condition.
- DO** - Read all operating instructions before commencing to operate Ride on lawnmower.
- DO** - Carry out all maintenance tasks without fail.
- DO** - Keep the air cleaner clean.
- DO** - Ensure that the correct grade of lubricating oils is used and that they are replenished and changed at the recommended intervals.
- DO** - Fit new sealing rings when the filter elements are changed.
- DO** - Watch the oil pressure gauge or warning light and investigate any abnormality immediately.

- DO** - Keep the radiator filled with clean water and in cold weather use anti-freeze mixture. Drain the system only in an emergency and fill before starting the engine.
- DO** - Ensure that the transmission is in neutral before starting the engine.
- DO** - Keep all fuel in clean storage and use a filter when filling the tank.
- DO** - Attend to minor adjustments and repairs as soon as necessity is apparent.
- DO** - Allow the engine to cool before removing the radiator filler cap and adding water, remove the radiator cap slowly.

- DO** - Shift into low gear when driving down steep hills.
- DO** - Latch the brake pedals together when driving on a highway.
- DO** - Keep draft control lever fully down when not in use.



SAFETY PRECAUTIONS

DON'TS-FOR SAFE OPERATION

- DON'T** - Run the engine with the air cleaner disconnected.
- DON'T** - Start the Ride on lawn-mower in an enclosed building unless the doors and windows are open for proper ventilation.
- DON'T** - Operate the Ride on lawn-mower or engine while lubricating or cleaning.
- DON'T** - Allow the Ride on lawn-mower to run out of diesel fuel otherwise it will be necessary to vent the system.
- DON'T** - Temper the fuel injection pump, If seal is broken the warranty becomes void.
- DON'T** - Allow the engine to run at low idle for a long period.
- DON'T** - Run the engine if it is not firing on all cylinders.

- DON'T** - Use the independent brakes for making turns on the highway or at high speeds.
- DON'T** - Refuel the Ride on lawn-mower with the engine running.
- DON'T** - Mount or dismount from the right side of the Ride on lawnmower.
- DON'T** - Temper the hydraulic control levers' upper limit stops.
- DON'T** - Use draft control lever for lifting of implements.
- DON'T** - Start the engine with the PTO engaged.
- DON'T** - Use the governor Control Lever (Hand throttle) while driving on roads.
- DON'T** - Move the hydraulic levers rearward.



INDEX

GENERAL INFORMATION		1
DESCRIPTION OF RIDE ON LAWNMOWER CONTROLS		2
MOWER		3
OPERATION		4
WORK PROCEDURE		5
MAINTENANCE		6
STORAGE AND DISPOSAL		7
TROUBLESHOOTING		8
SAFETY STANDARD FOR FARM WORK		9
APPENDIX		10
INDEX		11
WARRANTY DECAL INFORMATION		12



TABLE OF CONTENTS



GENERAL INFORMATION

1

- 1. EXTRRIOR VIEW 1-2
- 2. SAFETY SIGNS 1-5



DESCRIPTION OF RIDE ON LAWNMOWER CONTROLS

2

- 1. INSTRUMENT AND SWITCHES..... 2-2
- 2. OPERATION THE CONTROLS 2-12



MOWER

3

- 1. PREFACE 3-2
- 2. THE RIDE ON LAWNMOWER..... 3-3
- 3. THE MOWER 3-4
- 4. GENERAL OPERATION..... 3-5
- 5. SLOPE OPERATION..... 3-6
- 6. TRANSPORTATION 3-6
- 7. OPERATION(1) 3-7
- 8. OPERATION(2) 3-8
- 9. MAINTENANCE(1)..... 3-9
- 10. MAINTENANCE(2)..... 3-11
- 11. SAFETY DECALS 3-13

- 12. INFORMATIONAL DECALS 3-14
- 13. MID MOWER SPECIFICATION 3-16
- 14. LUBRICATION..... 3-18
- 15. SETTING MOWERS 3-19
- 16. MOWER ADJUSTMENT 3-22
- 17. METRIC FASTENER(ISO) TORQUE CHART.. 3-26
- 18. REPLACEMENT..... 3-27



OPERATION

4

- 1. ENGINE STARTING 4-2
- 2. ENGINE STOPPING 4-3
- 3. ENGINE IDLING 4-3
- 4. RUNNING-IN PERIOD 4-4
- 5. STARTING OFF, SHIFTING AND DRIVING... 4-4
- 6. STOPPING AND PARKING..... 4-4
- 7. DRIVING ON SLOPE 4-5
- 8. CAUTIONS FOR DRIVING INTO / OUT OF FIELD 4-6
- 9. LOADING TO / UNLOADING FROM TRUCK 4-6
- 10. CAUTIONS FOR DRIVING ON ROAD..... 4-7
- 11. OPERATION CHECK DURING DRIVING 4-7

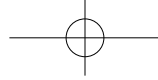

TABLE OF CONTENTS



WORK PROCEDURE

5

1. PRECAUTIONS FOR HANDLING IMPLEMENT 5-2



MAINTENANCE

6

1. OPENING COVERS 6-2
2. INSPECTION ITEMS 6-2
3. INSPECTING AND CHANGING COOLANT .. 6-4
4. CHECKING AND CHANGING OIL 6-5
5. REPLACING FILTER AND CARTRIDGE 6-9
6. FUEL SYSTEM 6-11
7. CHECKING AND CLEANING AIR CLEANER... 6-12
8. GREASING 6-13
9. CHECKING HOSES 6-13
10. CHECKING ELECTRIC SYSTEM 6-14
11. CHECK AND ADJUST EACH PART 6-18
12. ROUTINE MAINTENANCE SCHEDULE.... 6-21



STORAGE AND DISPOSAL

7

1. RIDE ON LAWNMOWER STORAGE 7-2
2. USAGE AND DISPOSAL 7-3



TROUBLESHOOTING

8

1. ENGINE SYSTEM 8-2
2. BRAKE SYSTEM 8-6
3. STEERING SYSTEM 8-6
4. HYDRAULIC SYSTEM 8-7
5. ELECTRIC SYSTEM 8-8



SAFETY STANDARD FOR FARM WORK

9

1. INSTRUCTION BEFORE USE 9-2
2. CHECKUP LIST BEFORE OPERATION 9-3
3. CAUTIONS DURING THE WORK 9-4
4. CAUTIONS WHEN DRIVING ON THE FARM ROAD.. 9-5
5. INSTRUCTION AFTER USE 9-6
6. CAUTIONS FOR INSPECTION AND MAINTENANCE . 9-6
7. RIDE ON LAWNMOWER 9-7



TABLE OF CONTENTS



APPENDIX

10

- 1. MAJOR SPECIFICATIONS 10-2
- 2. MAJOR CONSUMABLES 10-4



INDEX

11

- 1. INDEX..... 11-2



WARRANTY

12

- 1. WARRANTY 12-2

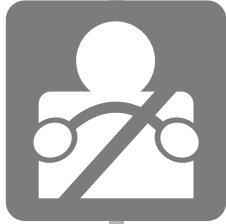
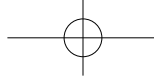

GENERAL INFORMATION

- 1. EXTRRIOR VIEW 1-2
- 2. SAFETY SIGNS 1-5



GENERAL INFORMATION

1. EXTRRIOR VIEW



TK0101B

1 - 2



GENERAL INFORMATION



1



TK0102B

1 - 3



GENERAL INFORMATION



Brake lamp

Turn signal lamp

1 - 4

TK0103A



2. SAFETY SIGNS

1

- **In order to work with the machine safely, safety decals are placed on the machine.**
- **Make sure to read and follow the directions.**

- **Keep the safety decals clean and undamaged at all times.**

If a safety decal on the machine is dirty, wash it with soapy water and wipe it off with a soft cloth.

Never use solution as thinner or acetone because these can erase characters or pictures.

- **If washed with high-pressured water, a decal may be peeled off.**

Do not apply high-pressured water directly onto decals.

- **If a safety decal is damaged or lost, order a new one immediately and place it on the machine.**

When putting a new decal, wipe off the place to post the decal thoroughly and wait until it is dried. Then post the decal.

Each decal has a part number on the bottom.

- **When replacing a part attached with a decal with a new part, replace the decal as well.**



GENERAL INFORMATION

EPA REGULATION

USE ULTRA LOW SULFUR FUEL ONLY

WARNING

Do not refuel the tractor while smoking or near naked flame or sparks. Always stop engine before refueling tractors.

1200-910-005-0

WARNING

- Start engine only from operators seat. If safety start switch is bypassed engine can start with transmission in gear.
- Do not connect or short across terminal on starter solenoid.
- Attach booster cables as shown on battery decal and operators manual.

Starting in gear causing runaway can result in serious injury.

WARNING

Always apply the park brake when parking. Failure to do so can cause accidents and damages.

1200-910-002-0

WARNING

Additions, alterations, cracking, damage or corrosion to this structure may adversely affect the performance of the ROPS.

DANGER

This Tractor may tip over unexpectedly and quicker than an operator is able to jump free

- Never operate a tractor without a proper Roll over Protection Structure.(ROPS)
- Always wear your seat belt when operating this tractor equipped with roll over protection.
- Never pull from above or from the rear axle.
- Do not operate the tractor on steep slopes or near drop offs
- Avoid sharp high speed turns

Serious injury or death may result from tractor upsets.

1220-904-501-0

WARNING

Do not use the accelerator lever except working on the field.

1200-910-021-0

WARNING

Death or injury may result if this tractor over turns with the ROPS in the folded down position. Operate this tractor with the ROPS folded down only when necessary. Do not wear seat belt if operated with ROPS folded down

1220-904-502-0



TK0104B

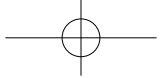

GENERAL INFORMATION

1



Operator's manual

1200-910-023-0

WARNING



Work in ventilated Area.

1200-910-003-0

WARNING



Do not remove radiator cap while engine is hot. Hot steam will injure you.

1200-910-015-0

CAUTION



Keep hands and clothing away from rotating fan and belts to prevent serious injury.

1200-910-012-0

CAUTION



Do not touch while the system is hot. It cause serious burns

1200-910-024-0



WARNING



Always fasten Your seat belt.

1200-910-019-0

DANGER



Do not ride except operator.



1200-910-016-0

WARNING



Never use the diff-lock at high speed or on the road as this can cause rollover and injury.

1200-910-005-0



1700-910-006-0

WARNING



FAST  SLOW (LOCK)

Always set the knob to lock when

- 1.Travelling on the road,
- 2.Replacing blades on an implement,
- 3.Making adjustment to an implement

Sudden dropping of an implement can cause serious injury or death.

1200-910-005-0

PARKING BRAKE

Press down the master brake pedal and lock the parking lever at the same time

TK0105B



GENERAL INFORMATION

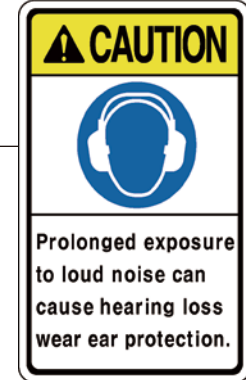
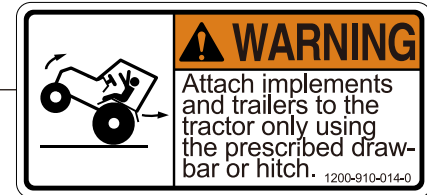
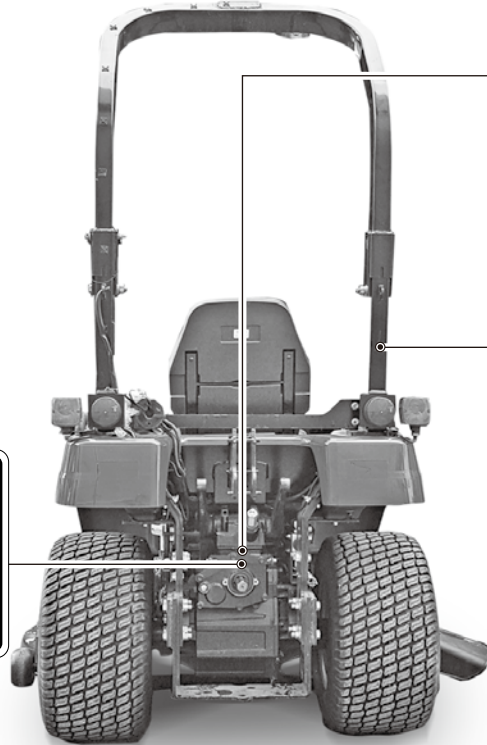
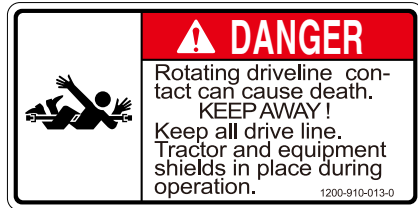



DESCRIPTION OF RIDE ON LAWNMOWER CONTROLS

1. INSTRUMENT AND SWITCHES 2-2

2. OPERATION THE CONTROLS 2-12



DESCRIPTION OF RIDE ON LAWMOWER CONTROLS

1. INSTRUMENT AND SWITCHES

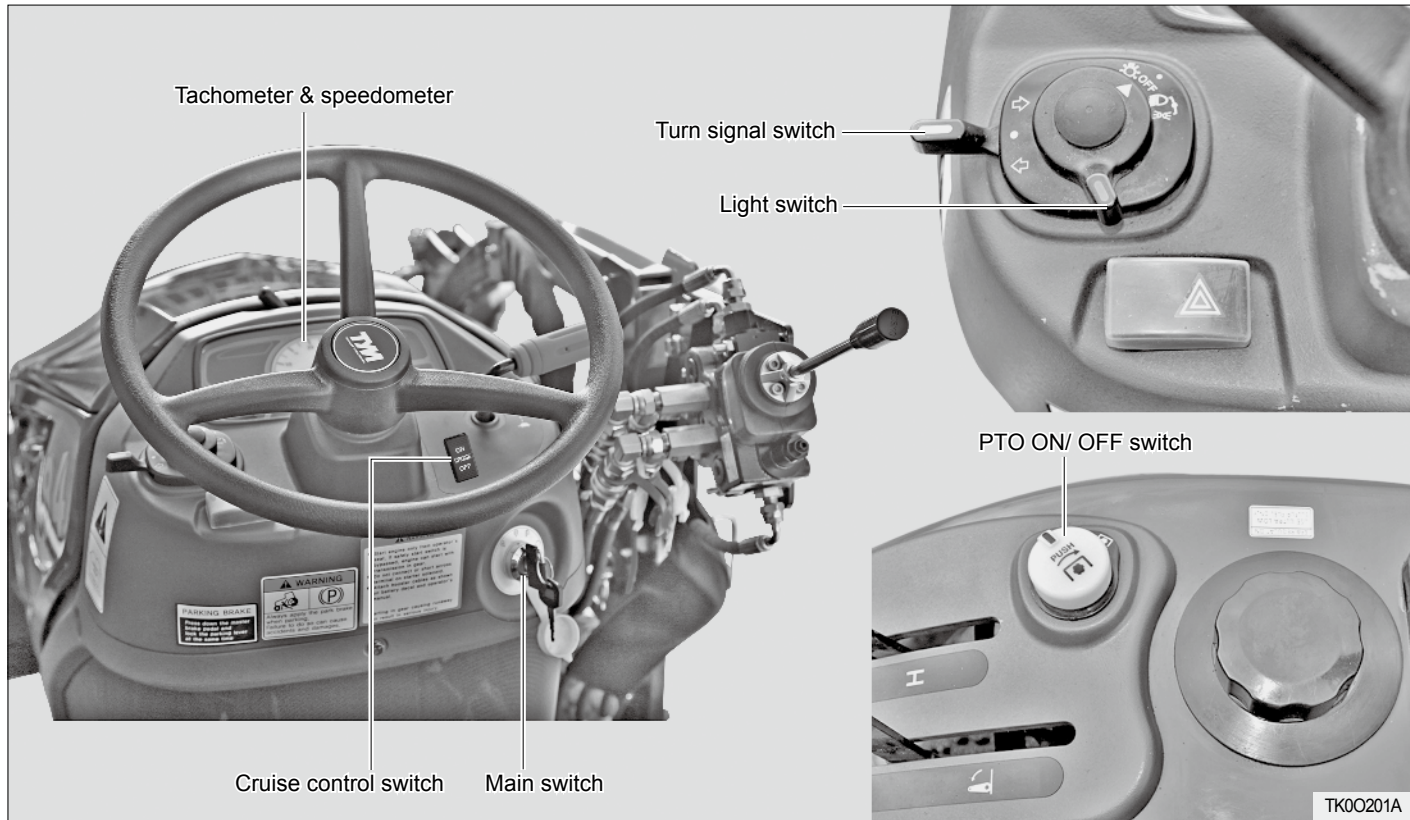

2 - 2

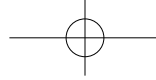

DESCRIPTION OF RIDE ON LAWNMOWER CONTROLS

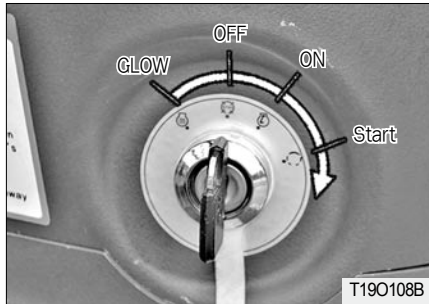

► MAIN SWITCH

It is used to start and stop the engine.

- **"OFF" position**

The ignition key can be inserted and removed in this position. When turning the switch to the OFF position with the engine running, the engine is stopped.

- **"ON" position**

The engine is kept running and the switch is energized in this position.

- **"START" position**

The engine can be started in this position. When releasing the key, the switch is returned to the "ON" position.

- **"GLOW" position**

The engine's combustion chamber is pre-heated in this position.

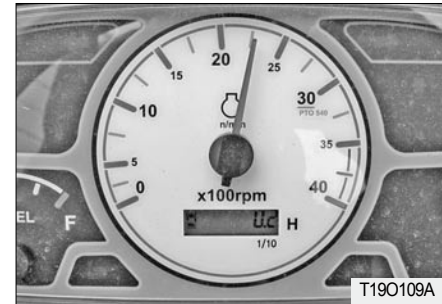

► TACHOMETER

It displays the revolution of the engine or PTO shaft per minute.

2



DESCRIPTION OF RIDE ON LAWNMOWER CONTROLS

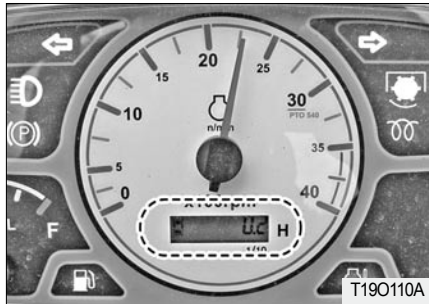

► HOUR METER

It indicates the total time of use. The last digit indicates one tenth hours. (decimal place) While the hour meter on the leftmost section is in operation, the lamp below it blinks.

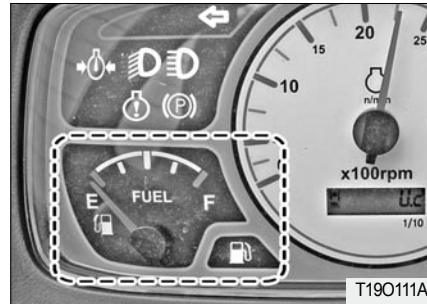

► FUEL GAUGE

This indicates the amount of fuel while the main switch is in the "ON" position.

- F - Full
- E - Empty

NOTE

- Poor fuel quality can damage the engine. Make sure to use only the specified genuine Diesel fuel.
- Use fuel for winter season in winter to enhance engine starting performance.

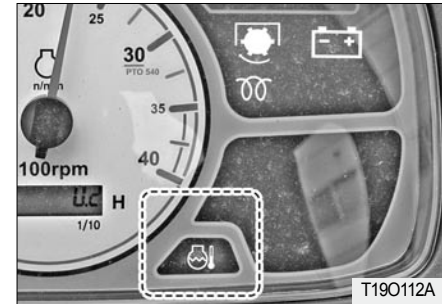

► COOLANT TEMPERATURE LAMP

This indicates the temperature of coolant while the main switch is in the "ON" position.

If the needle is in the red "H" zone during driving, the coolant is overheated. In this case, stop driving and take any necessary action according to the troubleshooting instructions.

☞ Ref to the page 7-4 for "Troubleshooting" section.

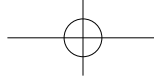

DESCRIPTION OF RIDE ON LAWNMOWER CONTROLS



NOTE

- The engine can be damaged if increasing its speed too fast.

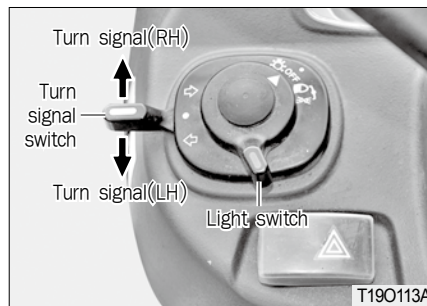

WARNING

- The high beam can obstruct the view of other drivers coming in the opposite direction on a road, leading to an unexpected accident.

2

► COMBINATION SWITCH

(1) Light switch operation

The light switch can be operated with the main switch in the "ON" position.

「OFF」 - All light OFF

 - Instrument lamp, tail lamp and low beam lamp ON.

 - Instrument lamp, tail lamp and high beam lamp ON.



DESCRIPTION OF RIDE ON LAWNMOWER CONTROLS

(2) Turn signal lamp operation

The turn signal lamps can be operated with the main switch in the "ON" position.

- Left turn

Turn the turn signal switch counter-clockwise. Then, the left turn signal lamp and the left turn signal indicator on the instrument cluster blink.

- Right turn

Push the turn signal switch clockwise. Then, the right turn signal lamp and the right turn signal indicator on the instrument cluster blink.

NOTE

- This lever is not automatically returned to the neutral position. Therefore, set it back to the neutral position after turn.

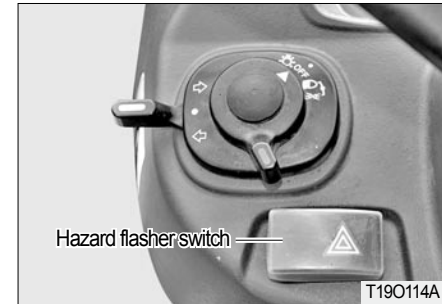

► HAZARD FLASHER SWITCH

This switch can be used to warn other vehicles when malfunction occurs in the Ride on lawnmower while driving on a public road. When pressing the switch once, the left and right hazard warning lamps blink. Pressing the switch again turns off the lamps.



DESCRIPTION OF RIDE ON LAWNMOWER CONTROLS



► MONITOR LAMP

2

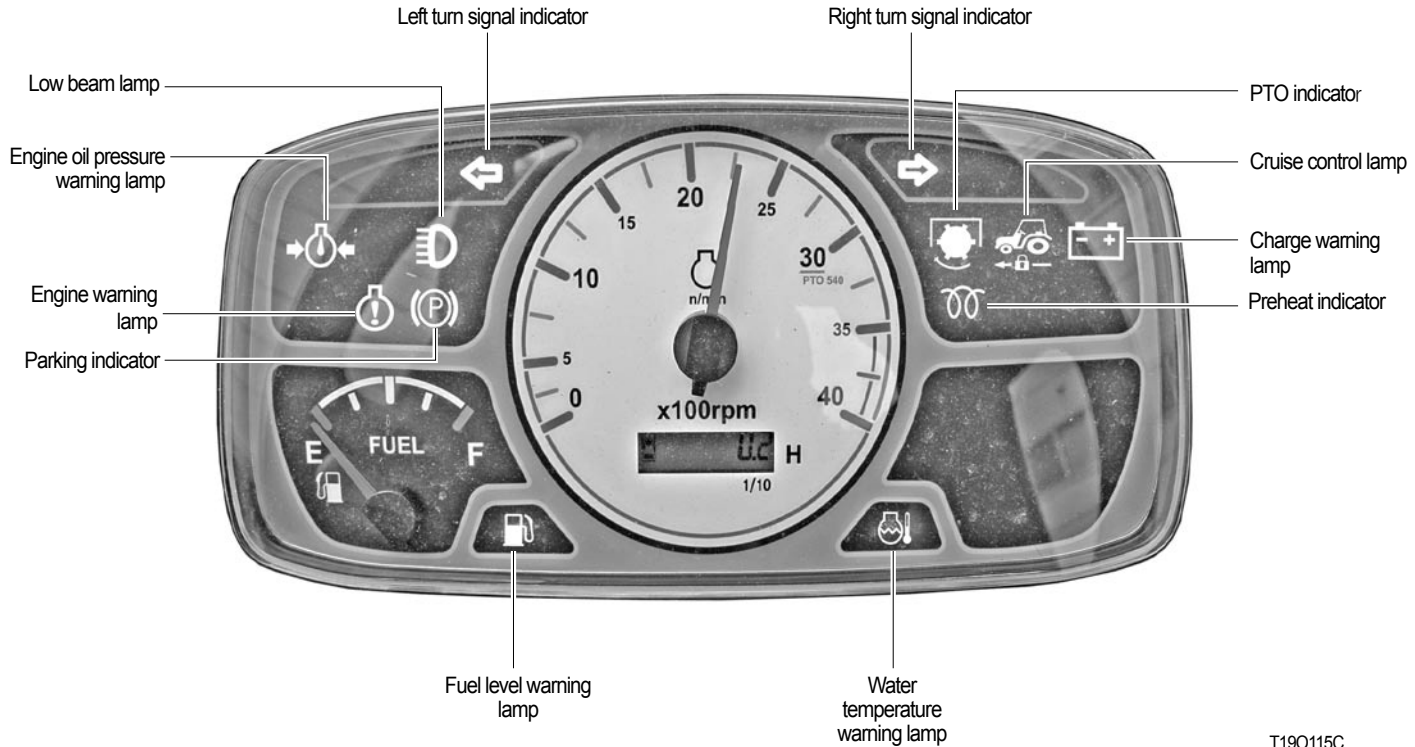

T190115C

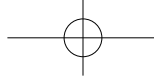

DESCRIPTION OF RIDE ON LAWNMOWER CONTROLS

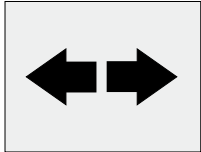

Left turn signal indicator

(1) Left turn signal indicator

This lamp is used to indicate the intended turning direction of the driver. When pulling down the turn signal switch, the left turn signal lamp blinks. When pushing up the turn signal switch, the right turn signal lamp blinks. These lamps are operated when pressing the hazard warning lamp switch as well.

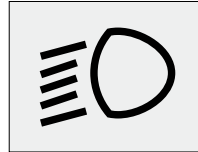

Low beam indicator

(2) Low beam indicator

This comes on when the low beam is turned on.

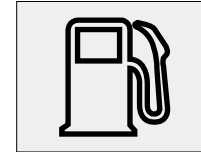

Fuel level warning lamp

(3) Fuel level warning lamp

If keeping driving with the needle of the fuel gauge pointing at 'E,' the warning lamp comes on which means there is only approx. 5 liters of fuel left in the tank.

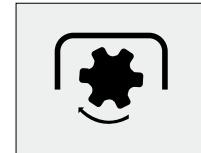

PTO indicator

(4) PTO indicator

This comes on while the PTO shaft is rotating.

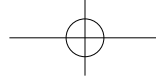

DESCRIPTION OF RIDE ON LAWNMOWER CONTROLS



2



Parking indicator

(5) Parking indicator

This comes on when the parking brake is applied.

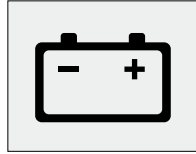

Charge warning lamp

(7) Charge warning lamp

This comes on when the main switch is turned to the "ON" position, and goes off as soon as the engine is started.

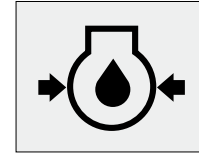

Engine oil pressure warning lamp

(8) Engine oil pressure warning lamp

This is illuminated when the engine oil pressure or oil amount is insufficient during driving.

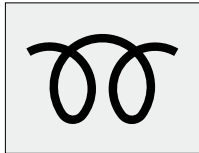

Preheat indicator

(6) Preheat indicator

This comes on while the engine preheating function is activated. It goes off as soon as preheating is completed.

NOTE

- If the charge warning lamp comes on while driving, the battery is not properly charged. Therefore, turn off any unnecessary electrical devices and have your vehicle checked by your workshop immediately.

NOTE

- When the oil pressure warning lamp comes on, this indicates malfunction of the lubrication system. Check the engine oil immediately and have your vehicle serviced by your workshop as necessary.



DESCRIPTION OF RIDE ON LAWNMOWER CONTROLS



Coolant temperature warning lamp

(9) Coolant temperature warning lamp

If this lamp comes on, coolant is overheated.

NOTE

- When the coolant temperature warning lamp comes on, coolant is overheated so check the coolant.

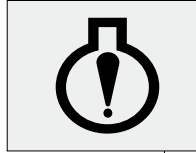

Engine warning lamp

(10) Engine warning lamp It comes on when the engine is malfunctioning.

CAUTION

- When Engine warning lamp is it, ensure that you operator the Ride on lawnmower only after the engine RPM reaches at the normal speed if this instruction is not kept, it may cause a performance degradation or accident due to a system error.

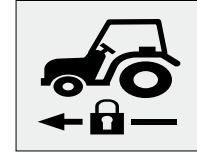

Cruise control lamp

(11) Cruise control lamp

This lamp will turn on when cruise control is engaged.



DESCRIPTION OF RIDE ON LAWNMOWER CONTROLS

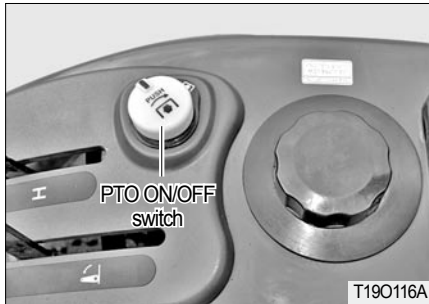

▶ PTO ON/OFF SWITCH

PTO ON/OFF switch is situated on the right hand side on the instrument panel and can be identified easily with its built in yellow colored indicator.

When the switch is pushed down to start the PTO indicator glows to indicate that the switch and the PTO are in ON position.

If the switch is pushed down and turn counter clock wise the indicator goes off signaling that the PTO is OFF.

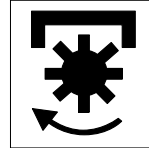
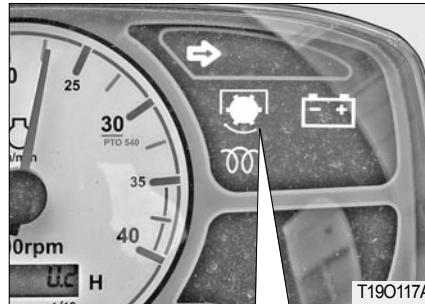

• PTO operation indicator

- ON - The PTO shaft is rotating.
- OFF - The PTO shaft is stopped.

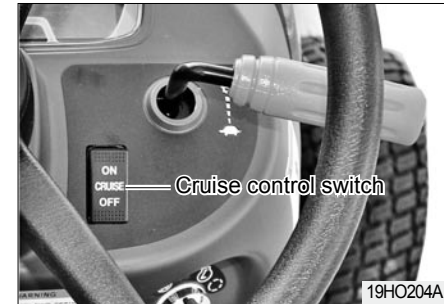

▶ CRUISE CONTROL SWITCH

When the switch is pushed ON Position, the cruise control is engaged and the switch light and indicator lamp on instrument panel are ON.

When the switch is pushed OFF Position or brake pedal is depressed, the cruise control and the lights are OFF.



DESCRIPTION OF RIDE ON LAWNMOWER CONTROLS

2. OPERATION THE CONTROLS

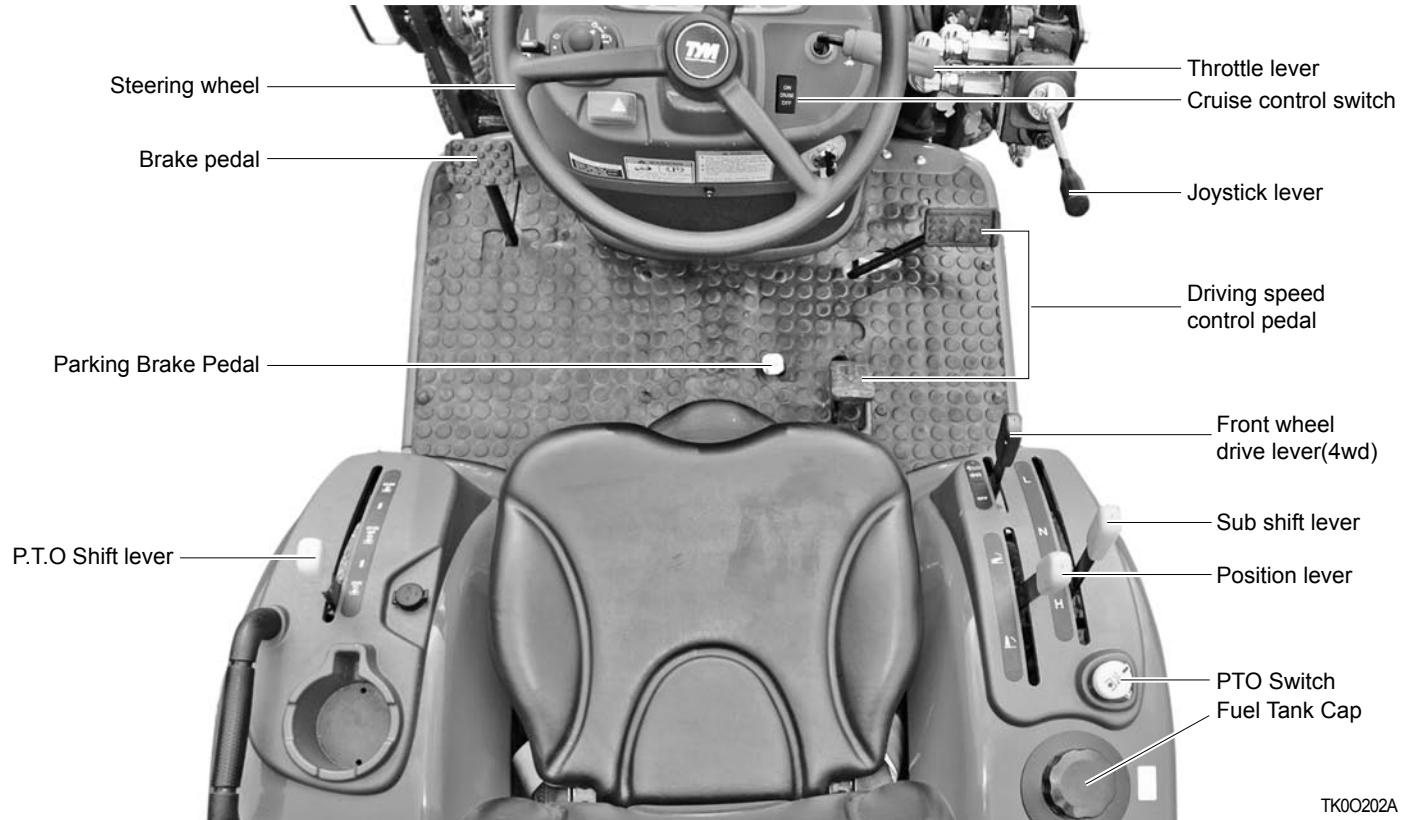

TK00202A

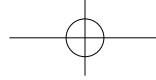

DESCRIPTION OF RIDE ON LAWNMOWER CONTROLS



2



► THROTTLE LEVER

It is used to adjust the engine speed like the throttle pedal.



Pushing : increasing speed



Pulling : decreasing speed

⚠ WARNING

- Never use it unless working in a field. It can lead to speeding and an accident.



► BRAKE PEDEL

The brake pedal is located on the LHS of the operator.

It is used for two functions.

- To stop the Ride on lawnmower
- To release cruise control

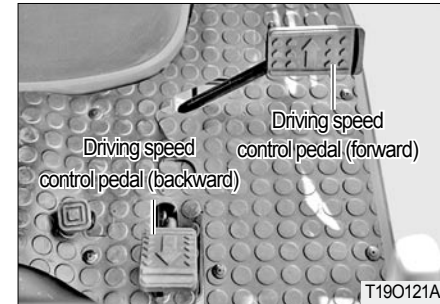

► DRIVING SPEED CONTROL PEDAL

When depressing the forward driving speed control pedal, forward driving is selected. Reverse driving is selected by depressing the reverse driving speed control pedal. When releasing the speed control pedal, it is returned to the neutral position and the Ride on lawnmower is stopped.

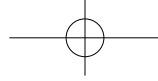

DESCRIPTION OF RIDE ON LAWMOWER CONTROLS

⚠ WARNING

- When switching the driving direction (forward/backward) directly during driving, a shock due to inertia can lead to an injury. Therefore, switch the driving direction while the Ride on lawnmower is stopped.
- Switch the driving direction only while you are on the driver's seat.

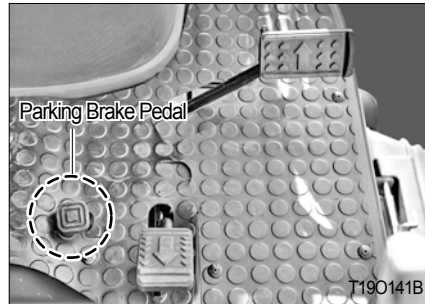

▶ PARKING BRAKE PEDAL

1. To engage the parking brake, at first depress the brake pedals down, and push the parking brake pedal down. At this time, Release the brake pedal first, then to be locked the parking brake pedal.
2. To release the Parking brake, depress the brake pedals again.

NOTE

- The brake discs can be worn prematurely if driving the vehicle with the parking brake engaged partially.

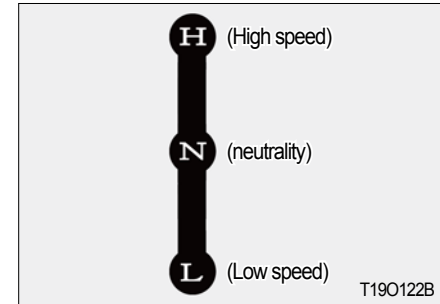

▶ SUB SHIFT LEVER

- The driving direction can be selected between forward direction and reverse direction using the shuttle shift lever and range shift lever.
- Use the throttle lever to increase/decrease the engine speed.



DESCRIPTION OF RIDE ON LAWNMOWER CONTROLS

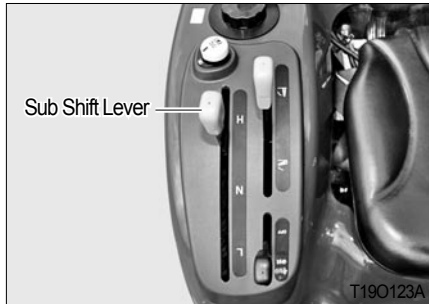

NOTE

- Operate the range shift lever only after the Ride on lawnmower is completely stopped and with the brake pedal depressed. Shifting the lever during driving can damage the gears.

WARNING

- When the range shift lever is placed in the position "H," the driving speed increased. Therefore, never put the range shift lever in the position "H" during driving backwards.

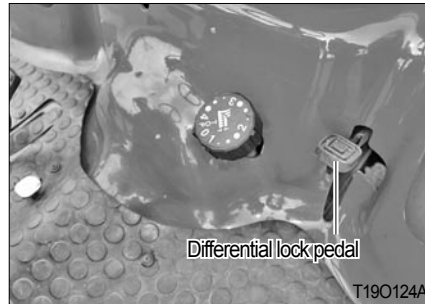

▶ DIFFERENTIAL LOCK PEDAL

The differential lock is a device to lock the differential system in order to rotate the left and right wheels at the same speed. This function can be used when the rear wheels slip or one wheel spins.



Engagement - Depressing pedal



Disengagement - Releasing pedal

WARNING

- Never use the differential lock when driving on a road. A collision or rollover can occur.
- Make sure to release it during turning. Otherwise, it can lead to an injury or accident.

NOTE

- When using the differential lock, run the engine at a low speed.
- If differential lock is still not disengaged after releasing the differential lock pedal, gently depress the left and right brake pedals alternately.

2

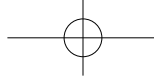

DESCRIPTION OF RIDE ON LAWNMOWER CONTROLS

< Examples of useful conditions of differential lock >

- ① One wheel slips or Ride on lawnmower cannot be driven forward when moving into/out of a field.
- ② A wheel slips during work requiring traction, such as plowing.
- ③ One wheel is stuck into a soft field and can't escape.

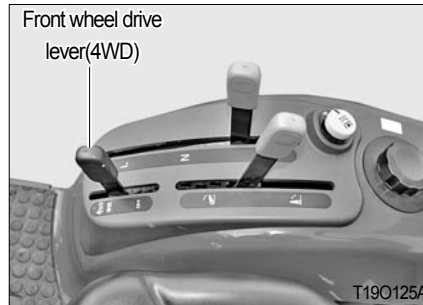

▶ FRONT WHEEL DRIVE LEVER (4WD)

Front wheel drive lever is located below the LHS of the Operator.

In the ON position the front wheels are engaged and in the OFF position they are disengaged.

Engage & disengage the front wheel drive with the front wheels in the straight position and at low speed.

< Examples of useful conditions of 4WD >

The 4WD can be used under the following conditions

- ① When cultivating in a field.
- ② When traction is required on a slope, in a wet field or for towing a trailer.
- ③ When working in a wet or sandy field.
- ④ When cultivating on firm soil with a rotavator to prevent the Ride on lawnmower from being pushed forward.
- ⑤ When driving into/out of a field or going over a field bank.



DESCRIPTION OF RIDE ON LAWMOWER CONTROLS



NOTE

- Before operating the 4WD lever, make sure to stop the Ride on lawnmower.
- To avoid damage of transmission, when front wheel drive lever is not smoothly shifted, slightly step forward or rearward on speed control pedal.
- Tires will wear quickly if front wheel drive is engaged on paved roads.

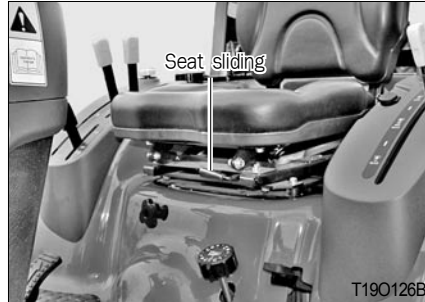

▶ SEAT AND SAFETY BELT

(1) Seat sliding

The seat can be adjusted by moving it forwards and backwards with the seat sliding lever on its front pushed to the left. After adjustment, make sure that the seat is firmly secured.

(2) Seat belt



Before driving, adjust the belt's length to fit to your body and insert it into its buckle. When it is engaged properly, a clicking sound is heard.

2



DESCRIPTION OF RIDE ON LAWNMOWER CONTROLS

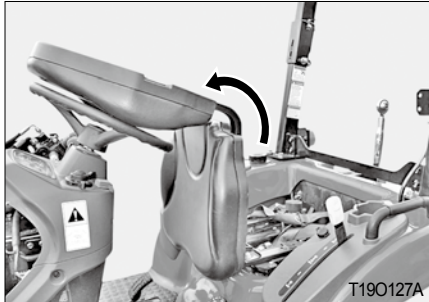

(3) Folding seatback

The seatback can be folded down when it is raining or for long-term storage.

WARNING

- Make sure to wear your seat belt to protect yourself from a possible rollover or crash accident.
- Never adjust the seat during driving.

▶ PTO

Both of the rear and mid PTO are provided for variable utility. They can be engaged simultaneously or separately at same time.

The engine will not start if PTO switch is ON position.

The engine will shutoff if the operator leaves the seat with parking brake released and PTO engaged.

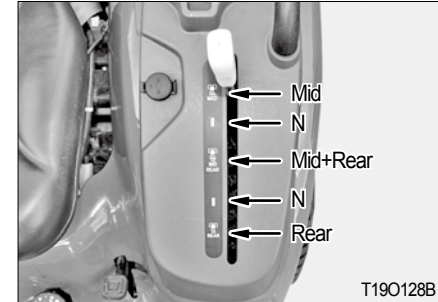

CAUTION

- To avoid damage of transmission and implement, do not engage PTO with the engine running at high speed.

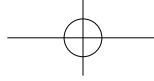

DESCRIPTION OF RIDE ON LAWNMOWER CONTROLS



▶ OPERATING TIPS FOR POWER STEERING WHEEL

- (1) Operate the power steering wheel only while the engine is running. You may feel the steering wheel heavier with a low engine speed.
- (2) When an implement, such as a loader, is attached to the front, the steering wheel may be felt heavy with the Ride on lawnmower stopped. If so, operate the steering wheel while driving the Ride on lawnmower at a low speed.
- (3) When the steering wheel is completely turned to one end, the safety valve is activated to output the audible signal (relief sound). When this sounds, avoid using the steering wheel (O.K. only for a short time). Also, never turn the steering wheel completely continuously.
- (4) Turning the steering wheel to its end unnecessarily (with the Ride on lawnmower stopped) can wear tires rapidly.
- (5) In winter, warm up the engine sufficiently before use.
- (6) When repairing components, such as a pipe, make sure that no foreign material enters the system.
- (7) The steering wheel can be operated with a small amount of force. Therefore, operate it with care and keep your hands on it at all times.

⚠ WARNING

- Releasing the steering wheel during driving can result in a collision and rollover. Never release the steering wheel during driving.

2

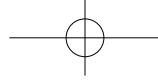

DESCRIPTION OF RIDE ON LAWNMOWER CONTROLS

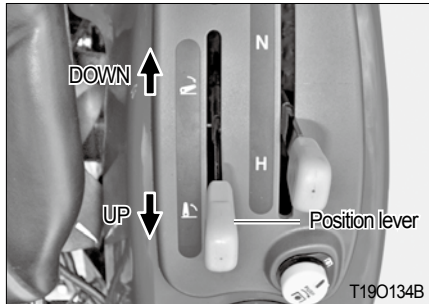

► IMPLEMENT LIFT CONTROL SYSTEM

(1) Position lever

This lever is used to lift and lower an implement to a certain working height freely and maintain it.

<Operation>

「Lifting implement」

Pull the lever back to lift the implement.

「Lowering implement」

Push the lever forward to lower the implement.

⚠ WARNING

- When leaving the Ride on lawnmower, make sure to lower the implement and stop the engine. Others may operate one of the controls, leading to a dangerous situation.

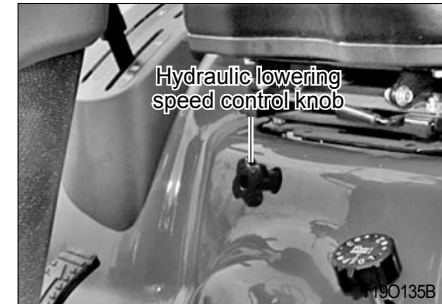

► HYDRAULIC LOWERING SPEED CONTROL KNOB

This can be used to adjust the lowering speed of the implement.

Adjust the lowering speed according to the implement type and working environment.

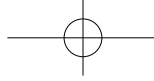

DESCRIPTION OF RIDE ON LAWMOWER CONTROLS



⚠ WARNING

Set it to the Lock position under the following conditions to prevent falling of the implement :

- When driving on a public road
- When replacing the rotavator blade or removing straws and grass
- When servicing the implement

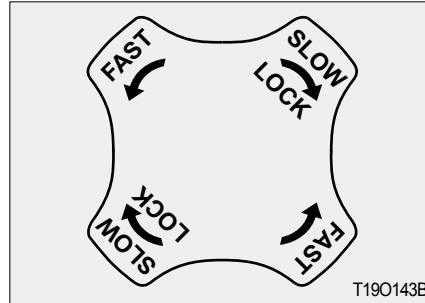

- Decreasing lowering speed
Turn the knob clockwise (slower).
- Increasing lowering speed
Turn the knob counterclockwise (faster).
- Lock
Turn the knob clockwise (slower) to its end.

▶ CONTROLLING

<Cruise Control>

The cruise control function is provided for comfortable and efficient operation. When the cruise control is engaged, the cruise control lamp on instrument panel will turn on.

1. Engaging the cruise control.

- ① Depress the forward speed control pedal till getting desired speed.
- ② Push the cruise control switch to engage cruise control
- ③ Release the speed control pedal

2. Disengaging the cruise control

There are two methods to disengage the cruise control.

- ① Push cruise control switch "OFF" or
- ② Depress the brake pedal.



DESCRIPTION OF RIDE ON LAWMOWER CONTROLS

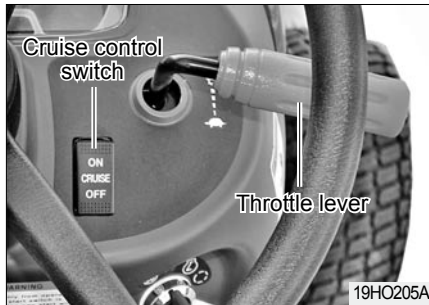

IMPORTANT

- To avoid damage of mechanism, do not depress both of the speed control pedals when the cruise control is engaged.

CAUTION

- To avoid personnel injury, do not use the cruise control in reverse.

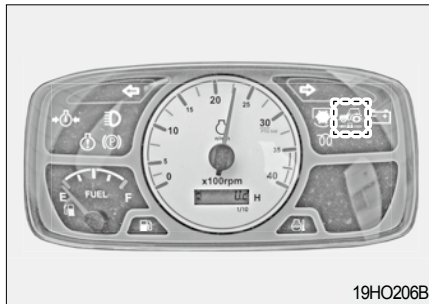

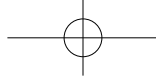

MOWER

- 1. PREFACE..... 3-2
- 2. THE RIDE ON MOWER 3-3
- 3. THE MOWER 3-4
- 4. GENERAL OPERATION 3-5
- 5. SLOPE OPERATION 3-6
- 6. TRANSPORTATION 3-6
- 7. OPERATION(1) 3-7
- 8. OPERATION(2) 3-8
- 9. MAINTENANCE(1)..... 3-9
- 10. MAINTENANCE(2)..... 3-11
- 11. SAFETY DECALS 3-13
- 12. INFORMATIONAL DECALS 3-14
- 13. MID MOWER SPECIFICATION 3-16
- 14. LUBRICATION 3-18
- 15. SETTING MOWERS 3-19
- 16. MOWER ADJUSTMENT 3-22
- 17. METRIC FASTENER(ISO) TORQUE CHART 3-26
- 18. REPLACEMENT 3-27



OPERATION

1. PREFACE

This manual is an integral part of the mower.

All operators must read the manual before operating the mower and must have access to this manual at any time.

The purpose of this manual is to provide information for the safe and correct use of the mower and the owner and or any operator of the mower must read this manual before operating the machine.

Every effort is made in this manual and verbally by selling Dealers to ensure the safe operation of this mower.

However as the actual operation is outside the control of Mahindra its Distributors or their Dealers, no liability of any kind is accepted for any injury or damage caused by incorrect operation of this mower.

► ASSISTANCE IN USING THIS MANUAL

For any assistance in the use of this manual or issues not dealt with in this manual please contact your selling Dealer.

If additional copies of the manual are needed they can be purchased from your selling Dealer.

For copies in a foreign language please ask your Dealer to make inquiry about the availability of a particular language.

► MACHINE USE

This machine is designed solely for use in customary lawn mowing operations. Use in any other way is considered as contrary to the intended use.

The manufacturer accepts no liability for damage or injury resulting from this misuse, and these risks must be borne solely by the user.

Compliance with and strict adherence to the conditions of operation, service and repair as specified by the manufacturer also constitute essential elements for the intended use.

This machine should be operated, serviced and repaired only by persons familiar with all its particular characteristics and acquainted with the relevant safety rules (accident prevention). The accident prevention regulations, all other generally recognized regulations on safety and occupational medicine and the road traffic regulations must be observed at all times.

Setting fuel delivery beyond published factory specifications or otherwise overpowering will result in loss of warranty protection for this machine.

Any arbitrary modifications carried out on this machine will relieve the manufacturer of all liability for any resulting damage or injury.



2. THE RIDE ON MOWER

1. Read, understand and follow all instructions in the manual and on the machine before starting. Failure to do so could result in serious injury or death and equipment damage. Keep this manual in a safe place for future and regular reference and ordering service parts.
2. Read and understand all Safety Precautions in the Ride on Mower Operator's Manual.
3. Allow only responsible operators familiar with the instructions to operate the machine. Know the controls and how to stop Ride on Mower engine and mower quickly in an emergency.
4. Ride on Mower must be equipped with Rollover Protective System (ROPS) and seat belt for all mower operations foldable ROPS systems locked in the up position at all times when operating the

mower. Falling off or overturning a Ride on Mower can result in death from being run over or crushed.

5. Always wear seat belt on Roll-over protective System (ROPS) equipped Ride on Mowers.
6. Wear personal protective equipment (PPE), such as, but not limited to, protection for eyes, ears, lungs, head, hair, hands and feet when operating, servicing, or repairing the equipment. Avoid wearing loose clothing or jewelry that may catch and entangle on entangle in moving parts.
7. Stop Ride on Mower engine, place in neutral, engage parking brake, lower mower deck to ground, stop all moving parts, remove ignition key to prevent unauthorized person.

8. Never leave the Ride on Mower with the mower blades rotating, with the Ride on Mower in motion, or the engine running.
9. Use fender hand holds and steps when mounting and dismounting Ride on Mower to prevent falls. Keep steps and Operator's platform clean and free of debris.
10. Move and turn Ride on Mower at low speeds. Avoid erratic operation and excessive speed.
11. Keep the Ride on Mower in gear when traveling down hill.
12. Do not mow near drop-offs, ditches, or embankments. The Ride on Mower could suddenly overturn if a wheel travels over the edge of a ditch, or if an edge caves in.
13. Add wheel ballast for stability when operating on slopes. Pay extreme care when operating on slopes to maintain stability.

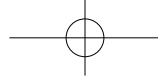

OPERATION

3. THE MOWER

14. Do not allow anyone but the operator on the Ride on Mower.
15. Pay extreme caution when loading or unloading the Ride on Mower from a trailer or truck.

1. Do not operate the mower unless it is rigidly attached to the Ride on Mower. Failure to do so could result in serious injury or death and equipment damage.
2. Make sure the locking spring on the shaft slides freely and make sure the balls are seated firmly in the groove of the PTO shaft.
3. Keep all shields and guards securely in place.
4. Never operate the mower with the discharge deflector in the raised position.
5. Stop Ride on Mower immediately upon striking a foreign object. Exit Ride on Mower in proper technique and procedure. Inspect and repair any damage before continuing mowing.
6. Stop Ride on Mower in proper procedure and wait until the mower blades stop completely, before unclogging discharge chute, adjustments, or removing any grass or debris from mower deck.

7. Make sure all hardware is properly tightened before operating the Ride on Mower. See torque chart specifications in this manual as well as the Ride on Mower manual. If none are available, contact your dealer for proper values.
8. Never adjust cutting height while Ride on Mower is running.
9. Make sure all Safety Decals are attached, clean, and free of debris so they are readable. Replace if damaged or worn.
10. Wear gloves when installing belt. Be careful to prevent fingers from being caught between belt and pulleys.
11. Be careful when installing or removing belt from spring loaded idler. Springs store energy when extended and if released suddenly, can cause injury.

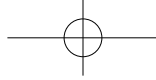

4. GENERAL OPERATION

1. Know your controls. Read this operator's manual and the manual provided with your Ride on Mower. Learn how to stop the Ride on Mower, the engine, and the mower quickly in an emergency.
2. Watch overhead clearances carefully before driving under power lines, bridges, tree branches, or when exiting or entering buildings. These situations may allow the operator to be struck or pulled from the Ride on Mower, which could result in serious injury or death.
3. Do not put hands or feet under the mower deck or near rotating parts.
4. Always wear safety glasses with side shields or safety goggles during operation.
5. Clear the area to be mowed of objects such as rocks, toys, wire, etc. which could be struck and thrown by the mower blades.

A thrown object by the mower could travel in any direction and cause injury to the operator or a bystander. To help avoid injury, keep bystanders, children, and pets at least 75 feet from mower while in operation. Stop the mowing operation if anyone enters the area.

6. Watch for hidden hazards in the area being cut during operation.
7. Disengage the mower before shifting Ride on Mower into reverse and backing up. Always look down and behind before and while backing.
8. Stop the mower blades when crossing gravel driveways, walks or roadways.
9. Watch for traffic when operating near or crossing roadways.
10. Never directly discharge towards people, pets or property.

11. To avoid injury from thrown debris, never operate the mower when it is raised in the transport position.
12. Never allow riders on Ride on Mower.
13. Operate only daylight or with good artificial light.
14. Do not attempt to mow through unusually tall, dry grass or piles of dry leaves. Debris may build up on the mower deck or contact the Ride on Mower exhaust causing a potential fire hazard.



OPERATION

5. SLOPE OPERATION

WARNING

- Slopes are a major factor leading to loss of control and tip over accidents, which can result in severe injury or death. All slopes require extra caution. If slopes are greater than 15 degrees, do not operate the mower on that area otherwise serious injury or death could result.

1. Add wheel ballast for stability when operating on slopes. Pay extreme care when operating on slopes to maintain stability.
2. Use extreme caution and reduce ground speed on slopes.
3. Do not stop, start, otherwise change directions suddenly on slopes. If the Ride on Mower tires lose traction, stop mower and proceed slowly straight down the slope.

4. To prevent loss of control and overturning the Ride on Mower, always mow up and down slopes, never across.
5. Do not operate or transport on steep slopes.
6. Do not mow on wet grass. Reduced traction could cause sliding on slopes.
7. Keep the Ride on Mower in gear when traveling down hill.

6. TRANSPORTATION

1. Always engage lift lockouts before transporting the mower.
2. Never allow riders on Ride on Mower.
3. Always use accessory lights and devices when transporting on a road or highway to warn operators of other vehicles. Check your local government regulations.
4. Be sure the slow moving vehicle (SMV) emblem is visible to the rear. If the SMV sign is worn, faded, or damaged, replace immediately.
5. Use caution and reduce speed when transporting under adverse conditions, turning, or on inclines.
6. Do not operate PTO during transport.

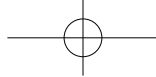

7. OPERATION(1)

⚠ WARNING

- Make sure Deflector Chute is installed and correctly functioning to prevent injury.
Never operate mower with chute removed or raised out of operating position.
- To avoid injury never direct the discharge of material towards bystanders or allow anyone near the machine while in operation.

⚠ CAUTION

- To avoid injury and damage, re-torque all fastening hardware, including blades end spindle retaining hardware after the first hour of operation.

Safe operation of the Ride on Mower is the responsibility of the operator.

Operator must be familiar with Ride on Mower controls and how they function, and all safety precautions before starting operation.

The mower is designed as a finish cut mower.

Do not allow anyone but the operator on the Ride on Mower. Never allow riders on Ride on Mower.

The deck cutting height is set by positioning the Clevis pin at the rear three-point Hitch area and allowing the Clevis pin to rest on the draw bar. Refer to "Cutting height. Adjustment" section of this manual for proper adjustment.

The anti-scalp wheels on each side of the mower deck can serve as a guide for mowing.

When mowing, position the mower deck such that the anti-scalp wheel overlaps the edge of the grass previously cut. This will assure full mower cut coverage.

Mowing should be performed with the Ride on Mower engine operating at the recommended RPM.

Do not mow at high ground speed. Operating at recommended RPM will insure proper blade speed for effective cutting and discharge of grass from the deck.

For best results, it is recommended that the first two passes around the area to be mowed has the discharge chute directed towards the center. After the first two passes have been completed, reverse direction to have the discharge chute pointed outward.

This will give a better appearance to the lawn.



OPERATION

8. OPERATION(2)

Blade sharpness will affect the appearance of the area cut. Dull or damaged blades will cause

the grass to appear torn, rather than cut cleanly.

Do not cut the grass too short. Short grass will promote weed growth and yellows in dry weather.

Allow grass to grow longer in hot, dry conditions. The additional length reduces heat build-up, preserves needed moisture and protects the grass from heat damage.

Mow often. Do not allow the grass to get too tall. Mowing areas with tall grass may require primary cutting at the maximum height. After completing the mowing operation at the maximum height, the area can be recut with the mower set at the desired height.

WARNING

- Make sure Deflector Chute is installed and correctly functioning to prevent injury.
Never operate mower with chute removed or raised out of operating position.
- To avoid injury never direct the discharge of material towards bystanders or allow anyone near the machine while in operation.

CAUTION

- To avoid injury and damage, re-torque all fastening hardware, including blades end spindle retaining hardware after the first hour of operation.

At certain times of the year and under some conditions, the mower may leave streaks of uncut grass.

The general cause is tall grass and weeds. With this type of condition, it may be necessary to make a second pass over the cut area to get an even cut.

Cutting off too much at one time shocks the plant's growth system and weakens the grass plants.

A good guideline to follow is the 1/3 rule: cut no more than one third of the grass height, and never more than 1 inch at a time.

Mow when the grass is 3 to 4 inches tall.

The time of day and condition of the grass will affect the results you obtain when mowing.

Mow at the time of day when the grass is cool and dry. Late afternoon or early evening will provide the most ideal conditions.



9. MAINTENANCE(1)

Do not mow when the grass is wet or heavy with dew.

Wet grass can build up on the underside of the deck, creating an imbalance through the blades and spindles, causing possible damage to the mower deck belt. Wet grass also leaves unsightly clumps on the lawn.

Should the mower deck become plugged, raise deck, shut off engine, set parking brake, and lock the deck in the transport position.

Clean the underside of the mower deck using a scraper.

Operate the mower only in daylight or with good artificial light.

1. Protect your eyes- Wear Safety Glasses.
2. Never run the Ride on Mower inside a closed area. Engine exhaust fumes can be lethal.
3. Always engage lift lockouts before servicing the mower.
4. Before performing any service work, make sure hoists, floor jacks, and jack stands are in good working order and properly rated to support the Ride on Mower.
5. Do not work under the Ride on Mower unless they are secured by a hoist and jack stands.
Never place any body part underneath equipment or between moveable parts even after Ride on Mower has been turned off. Hydraulic system leak downs, hydraulic system failures, mechanical failures, or control lever movement can cause mower and Ride

on Mower components to drop or rotate unexpectedly and cause serious injury or death.

6. Avoid injury, do not adjust, service, clean, or unclog the mower when the Ride on Mower engine is running.
7. Frequently check the mower blades.
They must be sharp and free of nicks, cracks and securely fastened.
8. Do not handle mower blades with bare hands. Wear leather gloves or wrap blades in the area Where they will be handled. Improper handling may result in serious injury.
9. Your dealer can supply genuine replacement blades. Non-genuine blades may not meet original equipment specifications and may be dangerous if installed.

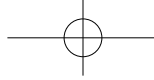

OPERATION

10. To reduce fire hazard, keep the Ride on Mower free of grass, leaves, or other debris build up.

Debris may build up on the mower deck or contact the Ride on Mower exhaust causing a potential fire hazard.

11. Never alter safety devices. Check their proper operation regularly. Use all guards as instructed in this manual.

12. It is not recommended to use a pressure washer to clean the mower assembly. High pressure water may cause damage to spindles, pulleys, belts, or bearings, shortening life and reducing serviceability.

**10. MAINTENANCE(2)****► FILLING DIAGRAM AND SERVICE INTERVALS**

Filling diagram shows the maintenances required and the intervals. Follow this checking schedule according to each indices to the satisfactory operation of the machine.

No.	Check Point	New	After first 10hrs	Every 50hrs	Every 150hrs	Every year	Every of work	Every end of work	Reference page
1	Gear box oil leakage check	○	○	○	○	○	○	○	
2	Gear box oil check		○	○	○	○	○		
3	Gear box oil change				◎	○			
4	Gear box oil seal change					○			At Breakage
5	whether blades are tightened up or not	○	○	○	○	○	○	○	
6	Blade wear check			○	○	○	○	○	
7	Blade balance and appearance check	○	○	○	○	○	○	○	
8	All hardware check	○		○	○	○	○		
9	whether all pins are in place or not	○		○	○	○	○	○	
10	Greasing check								
	• Pulley holder	○	○	○	○	○	○	○	
	• Belt tension pulley	○	○	○	○	○	○	○	
	• Belt tension arm	○	○	○	○	○	○	○	
	• Rear link shafts	○	○	○	○	○	○	○	
	• Universal Joint	○	○	○	○	○	○	○	



OPERATION

No.	Check Point	New	After first 10hrs	Every 50hrs	Every 150hrs	Every year	Every of work	Every end of work	Reference page
11	Front and rear wheel wear check				○	○	○		
12	Front roller wear check				○	○	○		

NOTE

- The schedule indicated by "◎" must be done after first 50 hours previously.
 - Oil Specification : SAE90
 - Oil Capacity : 0.3ℓ



11. SAFETY DECALS

1. Part NO : 9400-500-001-0
Located on RH and LH Belt Shields

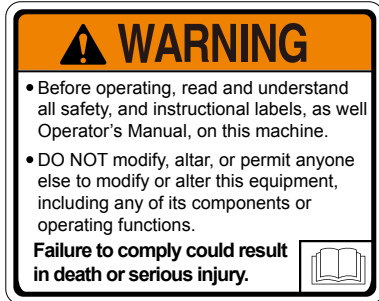

2. Part NO : 9400-500-002-0
Located on Deck Weldment



3. Part No : 9400-500-005-0
Located on Side Cover



4. Part NO : 9400-500-007-0
Located on Front of Deck Weldment



3



OPERATION

12. INFORMATIONAL DECALS

5. Part NO : 9380-500-003-0
Located on Front of Deck Weldment

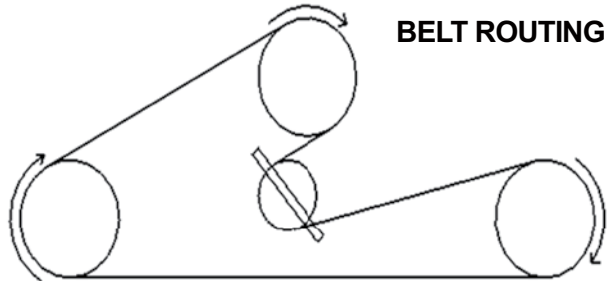

6. Part NO : 9397-500-008-0
Located on Deck Weldment

SOM

7. Part NO : 9400-500-004-0
Located on Right of Deck Weldment

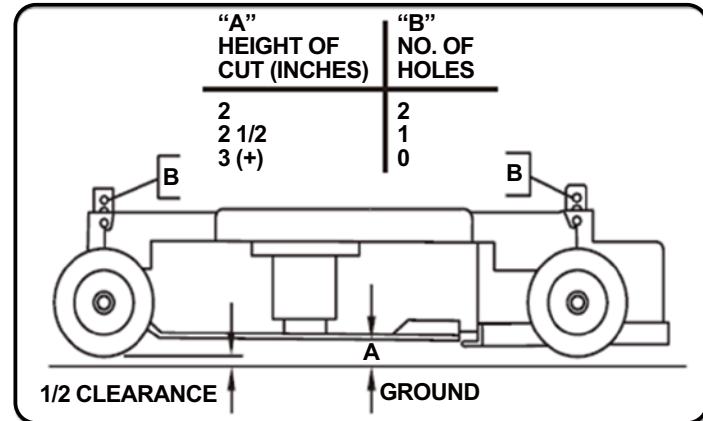



OPERATION

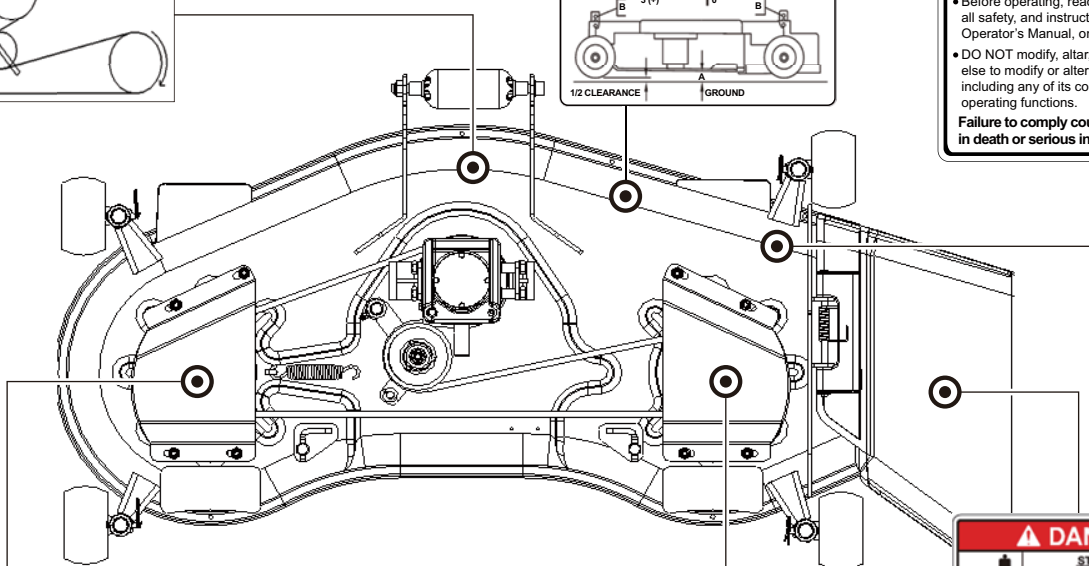
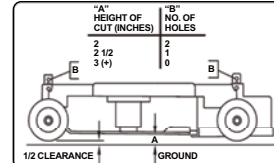
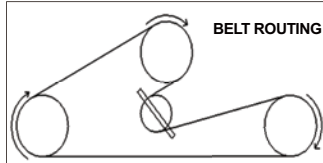

WARNING

- Before operating, read and understand all safety, and instructional labels, as well Operator's Manual, on this machine.
- DO NOT modify, alter, or permit anyone else to modify or alter this equipment, including any of its components or operating functions.

Failure to comply could result in death or serious injury.

3

WARNING

**SHIELD MISSING / OPEN
DO NOT OPERATE**

Replace or close shield before operating machine.

Failure to comply could result in death or serious injury.

⚠ DANGER

	STAND CLEAR • DO NOT stand near mower when in operation.
	ROTATING BLADES • DO NOT put hands or feet under or into mower when engine is running.
	THROWN OBJECTS • Before mowing, clear area of bystanders and objects, that may be thrown by mower blades.
	DO NOT OPERATE MOWER • DO NOT remove air/fuel control pins, discharge deflector in place or without engine speed adjuster loosened. DO NOT ALLOW children to ride on mowing deck.

Failure to comply will result in death or serious injury.

TK0325A

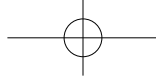

OPERATION

13. MID MOWER SPECIFICATION

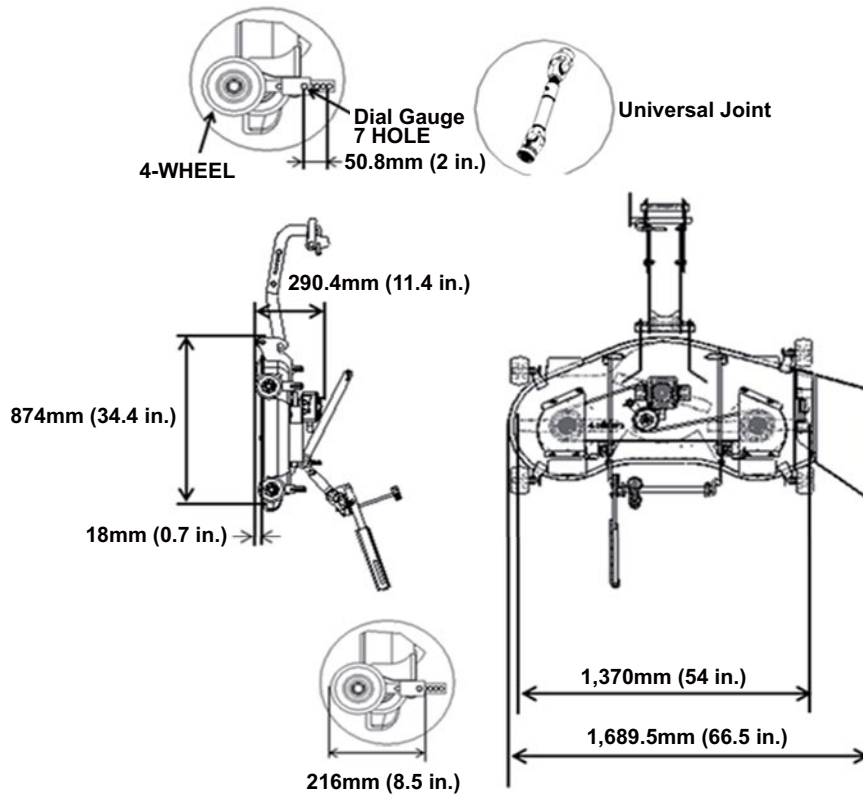

TK0302A

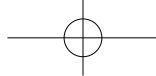

OPERATION



3

MODEL		MM54
Manufacturer		Side Discharge
Model		Parallel Linkage
Dimensions	Length (mm)	34.4
	Width (mm)	66.5
	Height (mm)	11.4
Working Width (in)		54
Cutting Height (in)		1 ~ 4
Transport Height (in)		5.6
Lift Linkage Type		Lower Link Lift
Adjustment of Increment		Dial Gauge
Wheel Height	Hole	7 EA
	Gab between Hole (in)	0.5
	Total Gab (in)	3

MODEL		MM54
Number of Blades		3 EA
Blade tip Velocity (rpm)		14601
Blade Length (in)		18.5
HP rating		18 ~ 20
Deck Thickness (in)		0.13
Weight (lb)		186
Universal Joint (mm)		Ø21.6X470L
Wheel		4 EA
Assistant Wheel		1 EA
Belt		V-Belt
Color		RED



OPERATION

14. LUBRICATION

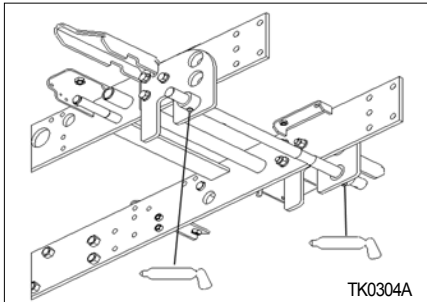
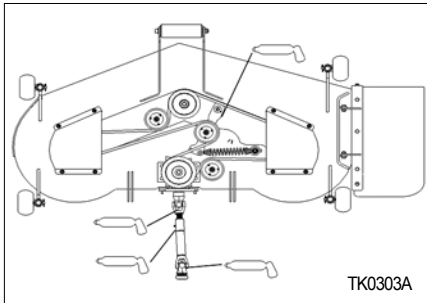

CAUTION

- It is not recommended to use a pressure washer to clean the mower assembly. High pressure water may cause damage to spindles, pulleys, belts, or bearings shortening life and reducing serviceability.

Life of the mower depends upon the maintenance given. Proper lubrication is very important.

Always lubricate the deck and lift components before operation.

Always wipe the fittings to be lubricated with a clean cloth before greasing. Dirt injected into the fitting will cause damage to the machined parts.

Use SAE Multi-purpose lithium base grease on all lubrication locations shown below. Remember to wipe away excess grease, which has built up around parts.

Lubricate grease fittings after every 50 hours of operation.

Miscellaneous working parts not provided with lubrication fittings should be oiled daily with a good grade of lubricating oil.

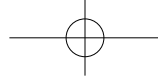

15. SETTING MOWERS

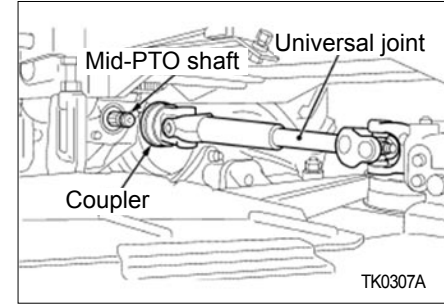
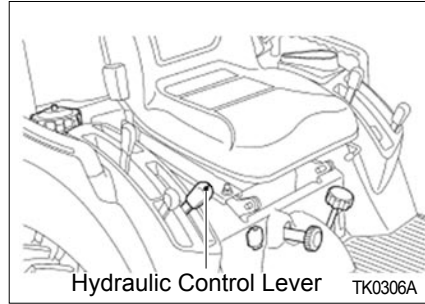
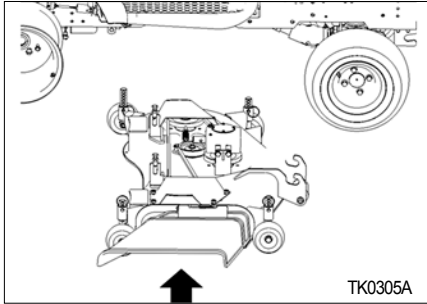

3

CAUTION

- Park the Ride on Mower on a firm, flat and level surface, set the parking brake, stop the engine and remove the key.

1. Start the engine and move the hydraulic lever rearward to raise the mower rear link to the highest position.
2. Stop the engine and remove the key.
3. Push the mower under the Ride on Mower from right side or ride on Ride on Mower.

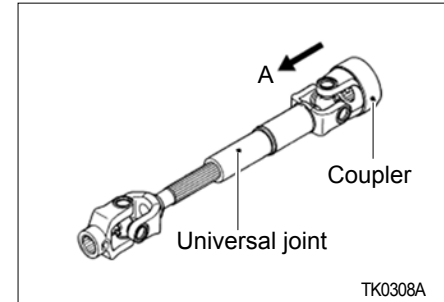

► UNIVERSAL JOINT

1. Pull back the coupler of the universal joint.
2. Push the universal joint onto the mid-PTO shaft, until the coupler locks.



OPERATION

- Slide the universal joint back and forward to make sure the universal joint is locked securely.

NOTE

- Finally, tug on the universal joint to make sure it is locked on the PTO shaft.

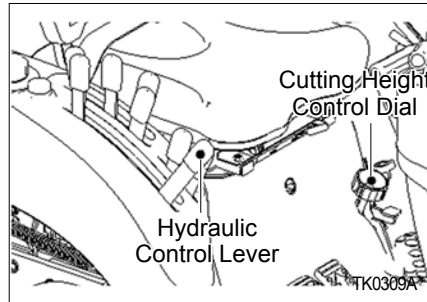

- Operate hydraulic control lever forward to lower the mower rear links.

Attach the rear link to the mower with the L-pins.

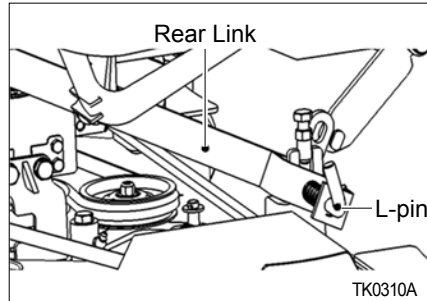

► REAR LINK

- Set the cutting height control dial to zero inch position.

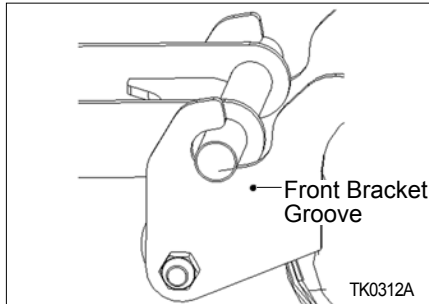
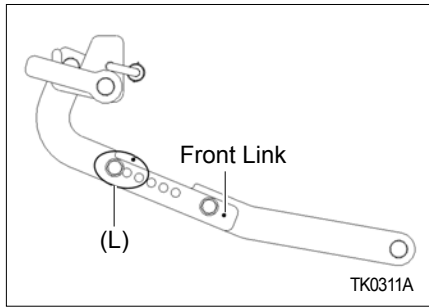

► FRONT LINK

1. Hook the front link to the front bracket groove as shown in the figure.

NOTE

Make sure the position (L) of the front link is 1st or 2nd hole.

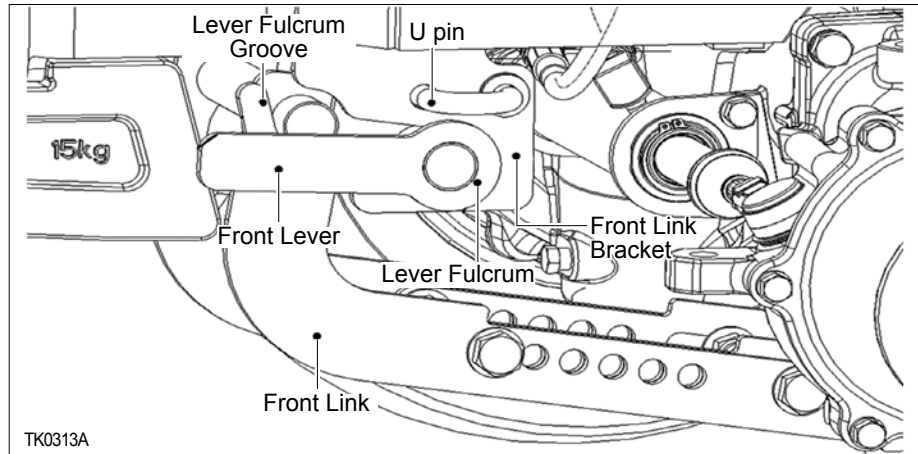

► MOUNTING FRONT LINK

1. Position the front lever to the front link bracket.
2. Pull and lock the U pin. Then lower the front lever.
3. Hook the front link to the lever fulcrum, and lift the front lever.
4. Release the U pin to lock the front lever.

NOTE

When hooking the front link to the lever fulcrum, normal position of the lever fulcrum groove is open to downward.

CAUTION

- Check that the front lever is locked securely with the L pin.



OPERATION

16. MOWER ADJUSTMENT

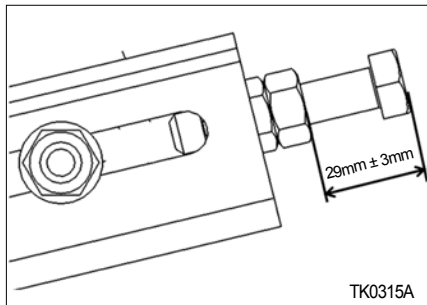
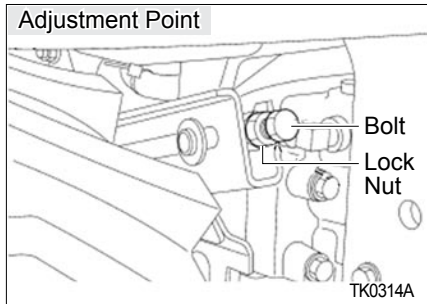

※ Bolt to Lock nut clearance
: 29mm ± 3mm

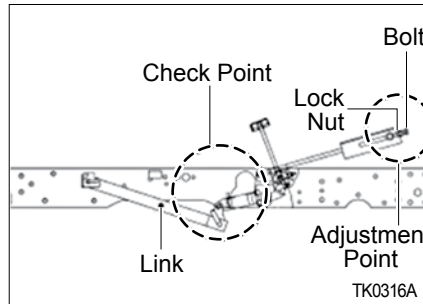

▶ ADJUSTING MOWER LINK

1. Tire pressure must be correct.
2. Move the hydraulic control lever rearward to raise the mower to the highest position.
3. Stop the engine and remove the key.
4. Tighten the bolt and nut clearance 29mm - Assembly Lift link

⚠ CAUTION

- Park the Ride on Mower on a firm, flat and level surface and set the parking brake.
- Stop the engine, remove the key, and allow the blades to stop before making adjustments.
- Wear heavy gloves or wrap end of blade with a rag when you handle blades.
- Before starting the engine, set the PTO clutch lever to off position and range gear shift lever to the neutral position.

Bolt to Lock nut clearance	Factory spec.
29mm ± 3mm	0 to 0.5 mm (0 to 0.01 in.)

※ Set the mower height by adjusting the bolt (initial setting position)



OPERATION

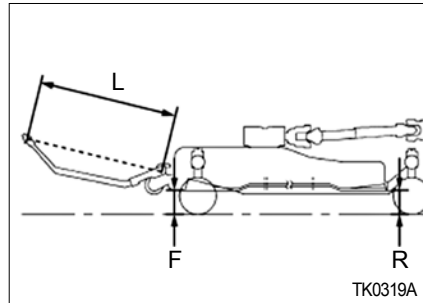
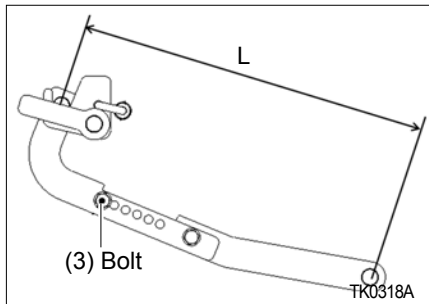
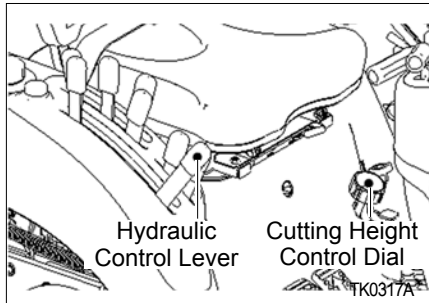

▶ ADJUSTING FRONT AND REAR CUTTING HEIGHT

1. Tire pressure must be correct.
2. Make sure the level of the mower blades is adjusted as shown below. Then tighten the lock nuts securely.
3. Turn the cutting height control dial to "2.0" and the anti-scalp roller's height to keep clearance between rollers and ground from 6 to 13 mm (0.25 to 0.5 in.).
4. Turn right blade by hand parallel to direction of travel.

5. Adjust (L) of front links with lock nuts so that A is 0 to 5 mm (0 to 0.2 in.) $A = (R) - (F)$.
6. If the difference between front tip and rear tip of blade is not within the factory specification, adjust the length L of front link with bolt (3). The height of rear blade tip R should be bigger than the front.

3

NOTE

L - MM54 : 530mm \pm 5mm

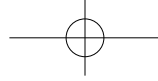

OPERATION

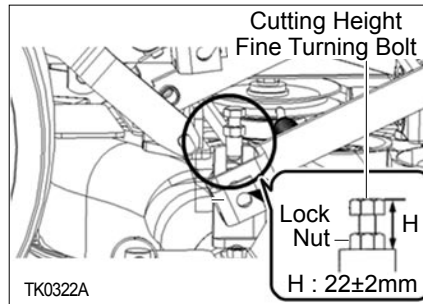
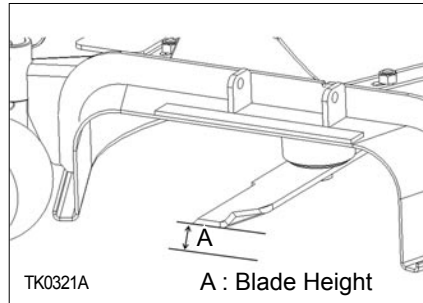
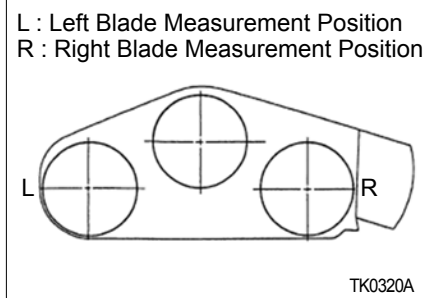
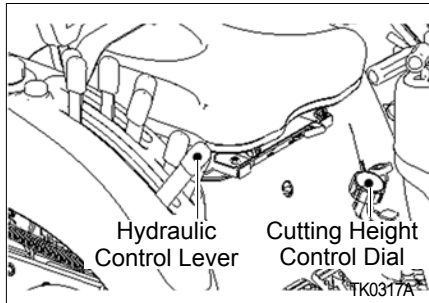

▶ ADJUSTING LEFT AND RIGHT CUTTING HEIGHT

1. Tire pressure must be correct.
2. Operate the hydraulic control lever rearward to raise the mower deck to the highest position.
3. Stop the engine and remove the key.
4. Turn the cutting height control dial to the desired height.
5. Set the anti-scalp roller's height to keep clearance between rollers and ground from 6 to 13mm (0.2 to 0.5 in.).
6. Lower the mower deck by moving the hydraulic control lever forward.
7. Turn left blade by hand parallel to Ride on Mower axle and turn right blade parallel to axle to measure from the outside blade tip at L and R to the level surface.



OPERATION



3

8. The difference between measurement should be less than 3mm (0.12 in.).
9. If the difference between measurement is more than 3mm (0.12 in.), loosen the lock nut of the left side.
10. Adjust the cutting height fine turning bolts so that the difference between measurement L and R is less than 3mm (0.12 in.). Then lock the nut.

Difference (L-R)	Factory spec.
Between left tip and right tip of blade	Less than 3mm (0.12 in.)



OPERATION

17. METRIC FASTENER(ISO) TORQUE CHART

NOTE

Use these torques. Unless special torques are specified. Values are for UNF thread fastener, plated or un-plated as received from supplier. Fasteners can be dry or lubricated with normal engine oil. Values do not apply if graphite. Moly-disulphide or other extreme pressure lubricant is used.

ISO Class No.	8.8				10.9				12.9			
Bolt identification (see note 1)												
Bolt Size	LB FT		NM		LB FT		NM		LB FT		NM	
	MIN	MAX	MIN	MAX	MIN	MAX	MIN	MAX	MIN	MAX	MIN	MAX
M4	2	3	3	4	3	4	4	5	Because of the low ductility of these fasteners, the torque range is to be determined individually for each application. As a general rule, the torque ranges specified for grade 10.9 fasteners can be used satisfactorily on 12.9 fasteners * M14 is not a preferred Size.			
M5	5	6	6.5	8	7	8	7.5	11				
M6	8	9	10.5	12	11	13	15	17.5				
M8	19	23	26	31	27	32	27	43				
M10	38	45	52	61	54	64	73	87				
M12	66	79	90	75	93	112	125	150				
*M14	106	127	144	172	149	179	200	245				
M16	160	200	217	271	230	280	310	380				
M20	320	380	434	515	450	540	610	730				
M24	500	600	675	815	780	940	1,050	1,275				
M30	920	1,100	1,250	1,500	1,470	1,770	2,000	2,400				
M36	1,600	1,950	2,175	2,600	2,580	3,090	3,500	4,200				



18. REPLACEMENT

⚠ DANGER

A worn or damaged blade can break, and a piece of the mower blade could be thrown into the operator's or bystander's area, resulting in serious injury or death

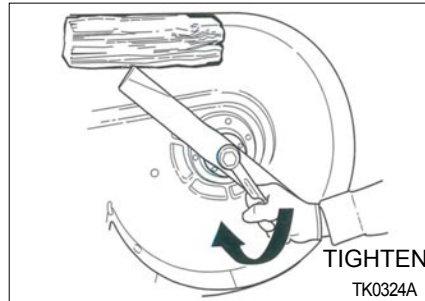
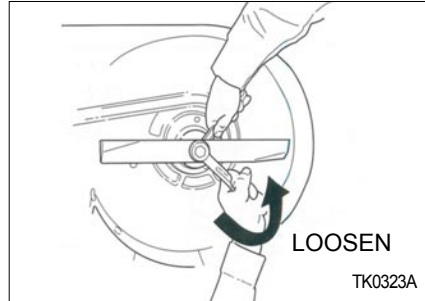

▶ BLADE REMOVAL

⚠ WARNING

- Do not work under a raised mower deck unless it is securely supported by a hoist or jack stands.
- Avoid injury when handling blades as they are sharp, wear leather gloves or protective wrap

Remove the blades using a wrench to loosen bolt securing the blade.

A block of wood must be placed between the deck housing and the blade to assist in removal of the bolt.



OPERATION

► BLADE INSTALLATION

When reinstalling the blade note orientation, the "wing" must be pointing upward the top of the deck.

► BELT REPLACEMENT

The mower deck belts should be replaced every 200 hours of mower operation, or anytime the belts shows sign of wear, cracking, or other damage.

Remove hardware securing the Left/ Right Hand Belt cover to the deck.

CAUTION

The Idler Arm with Idler Pulley are under spring tension. To prevent possible injury, use caution when handling the Idler Arm assmby.

Place a "Breaker Bar" in the square hole in the Idler Arm. Carefully push the Idler Arm towards the left hand side, away from discharge opening to relieve tension from the belt. Slip the belt off of the Right hand Spindle Pulley, then carefully release the Idler Arm.

Remove the belt from the Center Spindle Pulley.

Remove the belt from the first fixed Idler Pulley.

Remove the belt from the Left Hand Spindle Pulley.

Remove the belt from the Idler Arm Pulley.

Remove the belt from the Gear Box Pulley.

Remove the belt from the Second Idler Pulley.

Remove the belt from the deck and discard.

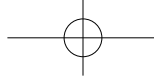

▶ BELT REPLACEMENT

Route the "backside" of the belt around the fixed Idler Pulley near Gear Box.

Route belt around Gear Box Pulley

Route the belt around the Idler Arm Pulley. The "backside" of the belt will be marking contact with the Arm Pulley.

Route belt around the Left Hand Spindle Pulley.

Route the "backside" of the belt around the fixed Idler Pulley near Center Spindle.

Route belt around the Center Spindle Pulley.

Make certain the belt is properly engaged in each pulley, then place a " Breaker Bar" in the square hole provided in the Idler Arm. Carefully push the Idler Arm towards the left hand side, away from discharge opening the relieve tension. Slip the

belt over the Right Hand Spindle Pulley, then carefully release the Idler Arm.

Reinstall Right Hand and Left Hand Belt covers to the deck

▶ GEAR BOX

CAUTION

Prior to operation, make sure the gear box contains the correct amount of oil. If under filled or overfilled, damage to the gear box or personnel injury may result.

The lubricant level should be checked each 24 hours of operation. After the first initial 50 hours of operation, drain the oil and refill to the proper level. Thereafter, oil changes should take place after every 250 hours of operation.

Removed plug located on side of gear box located on the side opposite of the fixed Idler Pulley

Correct oil level is to the center line of the drive shaft



OPERATION

- 1. ENGINE STARTING..... 4-2
- 2. ENGINE STOPPING 4-3
- 3. ENGINE IDLING..... 4-3
- 4. RUNNING-IN PERIOD 4-4
- 5. STARTING OFF, SHIFTING AND DRIVING 4-4
- 6. STOPPING AND PARKING 4-4
- 7. DRIVING ON SLOPE 4-5
- 8. CAUTIONS FOR DRIVING INTO / OUT OF FIELD.. 4-6
- 9. LOADING TO / UNLOADING FROM TRUCK 4-6
- 10. CAUTIONS FOR DRIVING ON ROAD 4-7
- 11. OPERATION CHECK DURING DRIVING..... 4-7

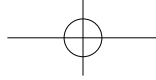

OPERATION

1. ENGINE STARTING

▶ HOW TO START ENGINE

- ① Make sure that there is no obstacle around the Ride on lawnmower.
- ② Seat on the driver's seat and confirm that the parking brake is applied.
- ③ Check that each shift lever and PTO switch are in the neutral position.
- ④ Pull the throttle lever halfway.
- ⑤ Insert the key into the main switch and turn the switch to the "ON" position. Check that the engine oil lamp and charge warning lamp come on.
- ⑥ Turn the main switch to the "START" position. When the engine is started, release the switch.
- ⑦ Confirm that all monitoring lamps go off after the engine is started.

⚠ WARNING

- Never start the engine by connecting the start motor terminal or safety switch directly. The Ride on lawnmower may move suddenly and cause an accident.

NOTE

- The engine will not start unless the brake pedal is depressed.
- Do not turn the main switch to the "START" position while the engine is running.
- Avoid running the start motor over 10 seconds. It consumes a lot of current.
- If the engine cannot be started within 10 seconds, wait for 30 seconds and try it again.
- The engine cannot be started unless the driver is seated on the driver's seat. Start the engine on the driver's seat.

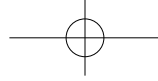

2. ENGINE STOPPING

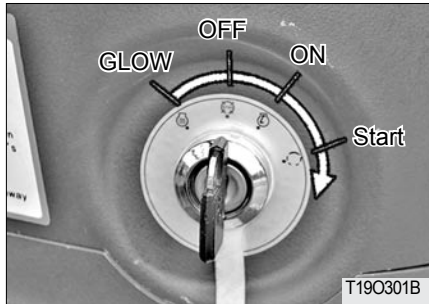

▶ STOPPING

- ① Idle the engine.
- ② Turn the main switch to the "OFF" position.
- ③ Remove the key from the switch.

NOTE

- Do not stop the engine at a high speed.
- If the engine has been running for an extended period of time, stop the engine only after idling it for 5 to 10 minutes.

3. ENGINE IDLING

▶ GENERAL ENGINE IDLING

After starting the engine, idle the engine for 5 to 10 minutes so that oil is delivered to each part of the engine.

NOTE

- If the engine is loaded right after it is started, it may cause engine stalling and failure. Make sure to idle the engine first.
- If neglecting to idle the engine, it can cause:
 - Seizure of the hydraulic pump
 - Failure in the hydraulic system.

⚠ WARNING

- Make sure to apply the parking brake while idling the engine.
- Never idle the engine in a poorly ventilated area. It can cause carbon monoxide poisoning by emissions.

▶ ENGINE IDLING IN COLD CONDITION

Hydraulic oil in this vehicle is also used as transmission fluid.

If the temperature drops in winter so oil gets cold, its viscosity rises and the hydraulic pump cannot suck oil in, causing malfunction.

Make sure to idle the engine in winter according to the following instructions.

Temperature	Idling time
0°C or higher (32°F or higher)	At least 10 min
0 ~ -10°C (32°F ~ -50°F)	10 ~ 20 min.
-10 ~ -20°C (-50°F ~ -68°F)	20 ~ 30 min.
-20°C or less (-68°F or less)	At least 30 min.

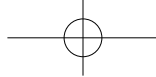

OPERATION

4. RUNNING-IN PERIOD

Make sure to keep the following instructions for the initial 50-hour use.

- (1) Avoid abrupt starting and abrupt stopping.
- (2) Do not use excessive speed or load.
- (3) Drive the Ride on lawnmower only when the engine is sufficiently warm.
- (4) Do not idle the engine at the maximum speed.
- (5) Check each part and change oil and fluid after 50-hour use.
- (6) Refer to the section Maintenance for adding and changing engine oil.

5. STARTING OFF, SHIFTING AND DRIVING

▶ STARTING OFF

- ① Lift an implement.
- ② Place the main shift lever, range shift lever and shuttle shift lever into the desired positions.
- ③ Depress the brake pedal to release the parking brake.

⚠ WARNING

- The driving speed in the reverse direction is almost the same to the speed in the forward direction. Make sure to check the surroundings carefully when driving backward.
- Especially, never drive backwards with the range shift lever in the position H. The driving speed becomes faster and it can cause an accident.

6. STOPPING AND PARKING



- ① Operate the throttle lever to set the engine at a low speed.
- ② Release the forward driving (HST type) and accelerator (mechanical) pedals slowly. Depress the brake pedals for abrupt braking.
- ③ When the vehicle is completely stopped, set the shift lever in the neutral position.
- ④ Apply the parking brake.
- ⑤ If an implement is attached to the vehicle, lower it.



7. DRIVING ON SLOPE

- ⑥ Remove the key from the switch after parking vehicle.
- ☞ Refer to the page 2-13 for operation of the parking brake.

⚠ WARNING

- After parking, make sure to apply the parking brake.
- Avoid parking on a slope if possible. If it is absolutely necessary to park on a slope, chock the rear wheels.

▶ STARTING OFF ON STEEP SLOPE

- ① Depress the brake pedals.
- ② Place each shift lever in the low speed position.
- ③ Set the engine at the mid speed with the throttle lever.
- ④ Release the brake pedal slowly at the same time.

▶ TIPS FOR DRIVING ON SLOPE

- (1) Set the main shift lever in the low speed position on a slope to prevent the engine from stopping.
- (2) Keep the driving speed low on a downhill road.

NOTE

- When the needle on the coolant temperature gauge is pointing at 'H,' the engine is overheated. If running the engine under this condition continuously, the engine parts can be severely damaged. Make sure to take an appropriate action immediately.



OPERATION

8. CAUTIONS FOR DRIVING INTO / OUT OF FIELD

- (1) Check that the left and right brake pedals are connected.
- (2) It is dangerous to drive into/out of a field if the field is deep from its bank.
Use ramps.
- (3) Move in the perpendicular direction to the bank.
- (4) When driving out of the field, lower the implement so that the front wheels cannot be lifted.
- (5) It is recommended to drive into a field backward to utilize full power.

WARNING

- Be careful to keep the Ride on lawnmower balance when working on a slope. The Ride on lawnmower may become out of balance and roll over.
- It is very dangerous to ride a person as a front weight.

 For detailed precautions, refer to the page 0-23.

9. LOADING TO / UNLOADING FROM TRUCK

- (1) When loading the Ride on lawnmower onto a truck, drive backward.
- (2) Be extra careful when using ramps.
- (3) If the engine stops on ramps, depress the brake pedals immediately and release them slowly to move onto the ground. Then, start the engine again to climb the ramps again.



10. CAUTIONS FOR DRIVING ON ROAD

- (1) When changing the direction on a road, use the turn signal lamp to inform other drivers.
- (2) Use the low beam when there is any vehicle coming on the other side at nighttime.
- (3) Check that the left and right brake pedals are connected.
- (4) Keep the work lamps off when driving at night.
- (5) Follow any applicable laws and drive safely.
- (6) Never let anyone ride the Ride on lawnmower, except yourself as a driver.

WARNING

- If driving on a road with an implement attached, the front side of the Ride on lawnmower tends to be lifted and the vehicle may not steer properly.

11. OPERATION CHECK DURING DRIVING

Observe that every part is properly operated during driving.

▶ ENGINE OIL PRESSURE

 If the engine oil level warning lamp comes on during driving, the lubrication system may malfunction. Check the engine oil immediately and have your vehicle checked by your workshop.

▶ CHARGING

 If the battery charge warning lamp comes on during driving, the battery is not properly charged. In this case, check the battery condition, and if necessary, have it checked by your workshop.

▶ ENGINE COOLANT

If the needle of the coolant gauge points at "H," stop the engine and check the followings:

- Radiator coolant
- Radiator fin for clogging
- Fan belt for looseness

If necessary, have your machine checked by your workshop.

NOTE

- When the coolant temperature warning lamp comes on, the engine is overheated. If running the engine under this condition continuously, the engine parts can be severely damaged. Make sure to take an appropriate action immediately.

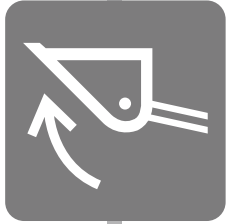

WORK PROCEDURE

1. PRECAUTIONS FOR HANDLING IMPLEMENT..... 5-2



WORK PROCEDURE

1. PRECAUTIONS FOR HANDLING IMPLEMENT

- (1) When driving the Ride on lawnmower to attach or detach an implement, make sure that there is no one in between or around the Ride on lawnmower and implement.
- (2) Install and remove the implement only on safe and level ground.
- (3) When installing a heavy implement, install weight on the front to keep balance.
- (4) When adjusting an implement, apply the parking brake, stop the engine and set the PTO switch in the OFF position in advance.
- (5) To tow anything, use the towing hitch only.

WARNING

- Read instructions on warning decals on each implement thoroughly before work.
- To avoid an injury due to mishandling of an implement, read the user's manual of the implement thoroughly and work safely and precisely with caution.
- Installation of an improper implement can lead to an injury. Install only implements specified by the Manufacturer.

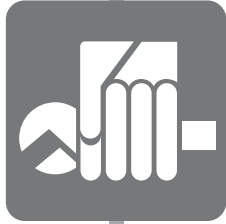
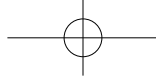

MAINTENANCE

- 1. OPENING COVERS..... 6-2
- 2. INSPECTION ITEMS..... 6-2
- 3. INSPECTING AND CHANGING COOLANT 6-4
- 4. CHECKING AND CHANGING OIL 6-5
- 5. REPLACING FILTER AND CARTRIDGE 6-9
- 6. FUEL SYSTEM 6-11
- 7. CHECKING AND CLEANING AIR CLEANER 6-12
- 8. GREASING 6-13
- 9. CHECKING HOSES..... 6-13
- 10. CHECKING ELECTRIC SYSTEM..... 6-14
- 11. CHECK AND ADJUST EACH PART 6-18
- 12. ROUTINE MAINTENANCE SCHEDULE 6-21



MAINTENANCE AND SERVICE

1. OPENING COVERS



▶ OPENING HOOD

- ① Slide the hook to the side. Then, the hood opens with a clicking sound.

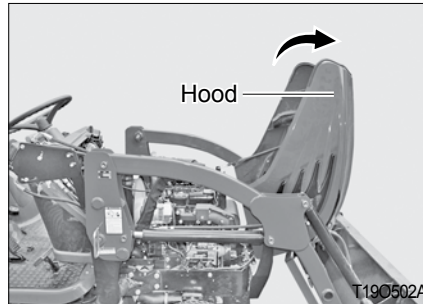

- ② Lift the hood with hands. Then, the hood is automatically opened and fixed by its damper.

2. INSPECTION ITEMS

To prevent any possible failure, some items should be checked daily.

Make sure to perform inspection before driving.

▶ INSPECTION ITEMS

Inspect each part in the following order:

- ① Check the items that were faulty yesterday.
- ② Go around the Ride on lawnmower and check:
 - Lamps for proper illumination and damage
 - Tires for inflation pressure, crack, damage and wear
 - Rotating parts for loose bolts and nuts
 - Transmission fluid level
 - Implement attachment status



③ Open the hood and check:

- Engine oil level
- Coolant level
- Fan belt for looseness and damage

④ Sit on the driver's seat, turn the main switch to the "ON" position and check:

- Fuel gauge for proper operation
- Fuel level
- Engine oil and charge warning lamps for blinking operation
- Turn signal lamp
- Horn operation
- Brake pedal free play

⑤ Start the engine, drive the Ride on lawnmower slowly and check:

- Emission color
- Brake pedal operation
- One brake pedal operation
- Steering wheel for heaviness and vibration
- Coolant gauge operation
- Hydraulic operation of 3-point link



MAINTENANCE AND SERVICE

3. INSPECTING AND CHANGING COOLANT

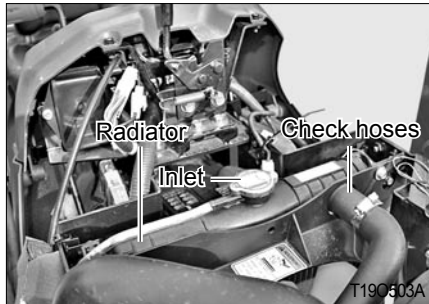

► ENGINE COOLANT INSPECTION AND CHANGE

(1) Inspection

Open the radiator cap and check that the radiator is filled with coolant up to its filler inlet. If the coolant amount is insufficient, add more coolant.

⚠ WARNING

- Do not open the cap when the engine is hot. Otherwise, hot steam can burn you seriously. Wait until the engine is sufficiently cooled down.

(2) Antifreeze

If coolant freezes, the engine can be damaged.

- Clean the radiator thoroughly before adding antifreeze.
- The mixture ratio of antifreeze is different by manufacturers and temperature. Refer to the manufacturer's manual.
- Mix antifreeze with water sufficiently before adding it.
- Adding antifreeze
 - If evaporated - Add water for the reduced amount.
 - If leaked - Add mixture of antifreeze and water with the same mixture ratio.

⚠ CAUTION

- If engine coolant gets on your skin, it can irritate the skin and cause a skin condition. Make sure to clean your skin with soap and water or hand cleaner thoroughly.

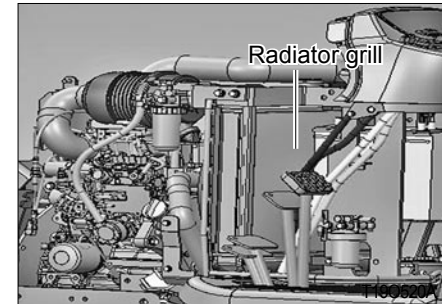

► CLEANING RADIATOR AND RADIATOR GRILLES

When working in a grassy field or working at night, the radiator or condenser grille may be clogged by grass, straws or bugs, reducing cooling performance.

In this case, clean the grille. If dust is stuck between the fan and tube, flush the area with clean water.

NOTE

- Do not clean the radiator fin with water jet. It can deform the fin.



4. CHECKING AND CHANGING OIL

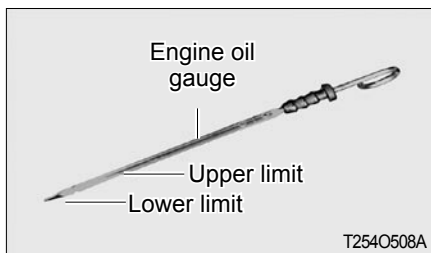
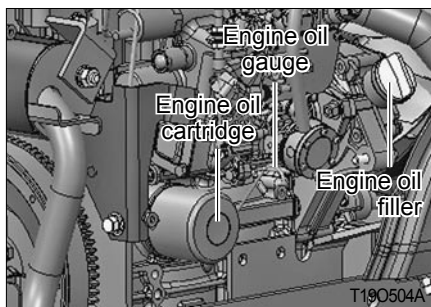

► CHECKING AND CHANGING ENGINE OIL

(1) Inspection

- ① Pull out the dipstick, wipe its tip and insert it again. Then, pull it out and check that the oil level is between the upper and lower limits.
- ② If insufficient, add oil.

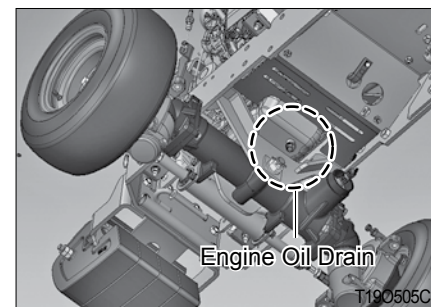

(2) Changing

- Unscrew the drain plug on the lower section of the engine to drain contaminated engine oil. Since hot oil flows out of the engine first, be careful not to get burnt.
- After draining oil, tighten the engine oil drain plug.
- Add the specified amount of the specified engine oil through the filler hole.

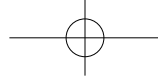

MAINTENANCE AND SERVICE

NOTE

- Do not add engine oil over the upper limit level.
- Check the engine oil before starting the engine or at least in 5 minutes after the engine is stopped.
- When trying to use new oil from a different manufacturer or oil with different viscosity, drain used oil completely before adding new oil.

(3) Oil specification

Diesel engine oil:

(API : CD/CF grades 10W/30)

CAUTION

- If engine oil gets on your skin, it can irritate the skin and cause a skin condition. Make sure to clean your skin with soap and water or hand cleaner thoroughly.
- Make sure to cool down the engine sufficiently before draining oil. Oil is very hot and can cause a burn if changing oil right after the engine is stopped.

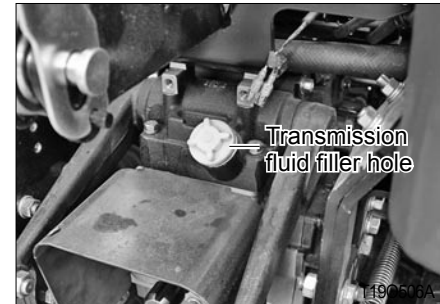

▶ CHECKING AND CHANGING TRANSMISSION FLUID

(1) Inspection

Perform inspection with the engine stopped.

- ① Check the transmission fluid level through the sight glass to see if the level is between the upper and lower limits.
- ② If insufficient, add oil.

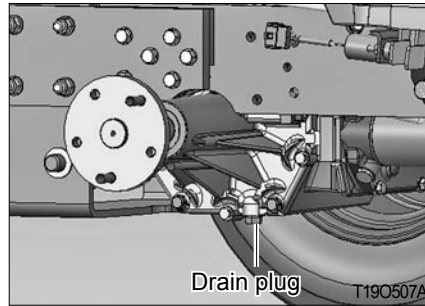
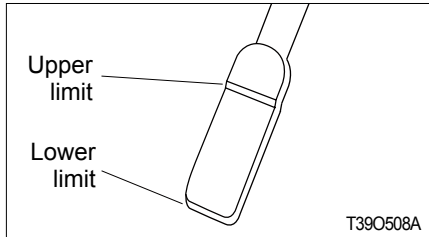

(2) Changing

- ① Unscrew the drain plug on the lower section of the transmission to drain contaminated transmission fluid. Since hot fluid flows out of the engine first, be careful not to get burnt.
- ② After draining fluid, tighten the transmission fluid drain plug.
- ③ Add the specified amount of the specified transmission fluid through the filler hole.

NOTE

- Do not add fluid over the upper limit level.
- Check the fluid before starting the engine or at least in 5 minutes after the engine is stopped.
- When trying to use new fluid from a different manufacturer or fluid with different viscosity, drain used fluid completely before adding new fluid.

(3) Oil specification

THF 80W

(API GL-4 Grade, Gear Oil 80W)

CAUTION

- If transmission fluid gets on your skin, it can irritate the skin and cause a skin condition. Make sure to clean your skin with soap and water or hand cleaner thoroughly.



MAINTENANCE AND SERVICE

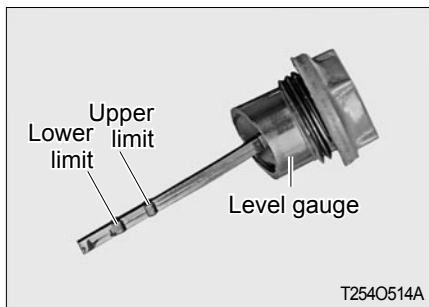
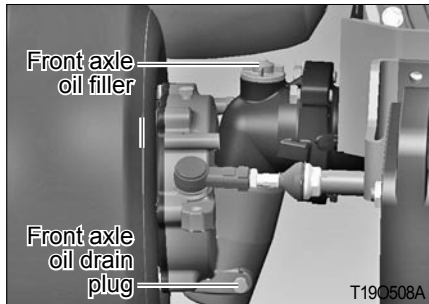

► CHECKING AND CHANGING FRONT AXLE OIL

(1) Inspection

- ① Pull out the dipstick, wipe its tip and insert it again. Then, pull it out and check that the oil level is between the upper and lower limits.
 - ② If insufficient, add oil.
- ※ There is one front axle oil drain hole on each side of the front axle.

(2) Changing

- ① Unscrew the drain plugs on the bottom of the axle and left/right final cases to drain engine oil. Since hot fluid flows out of the engine first, be careful not to get burnt.
- ② After draining oil, tighten the oil drain plug.
- ③ Add the specified amount of the specified oil through the filler hole.

NOTE

- Do not add front axle oil over the upper limit level.
- Check the front axle oil before starting the engine or at least in 5 minutes after the engine is stopped.
- When trying to use new oil from a different manufacturer or oil with different viscosity, drain used oil completely before adding new oil.



5. REPLACING FILTER AND CARTRIDGE

(3) Oil specification

Gear oil SAE 90W
(API GL-4 grade or higher)

CAUTION

- If oil gets on your skin, it can irritate the skin and cause a skin condition. Make sure to clean your skin with soap and water or hand cleaner thoroughly.
- Make sure to cool down the engine sufficiently before draining oil. Oil is very hot and can cause a burn if changing oil right after the engine is stopped.



▶ REPLACING TRANSMISSION FLUID FILTER CARTRIDGE

- ① The HST oil filter is located under the floor.
- ② Remove the hydraulic oil filter element by turning it counterclockwise with a wrench.
- ③ Apply a thin film of oil to the O-ring of a new cartridge and install the new cartridge by tightening it with a hand. When its packing touches the sealing surface, turn it approx. 2/3 turns further with a wrench.
- ④ Add hydraulic oil to the specified level.
- ⑤ Check the oil level with the dipstick again. If still insufficient, add more.

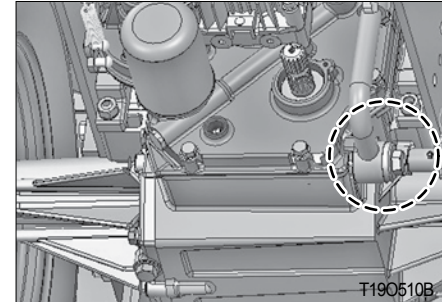

▶ TRANSMISSION STRAINER CLEANING

- ① When changing transmission fluid, clean with diesel fuel.
- ② Unscrew the filter body support bolt from the right lower section of the rear transmission case and gently pull the filter with pliers to remove it.



MAINTENANCE AND SERVICE

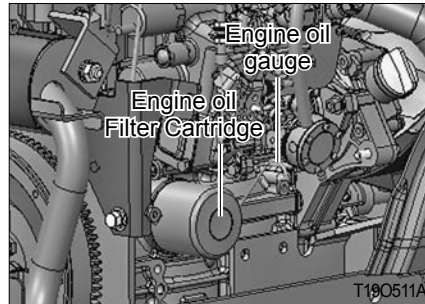
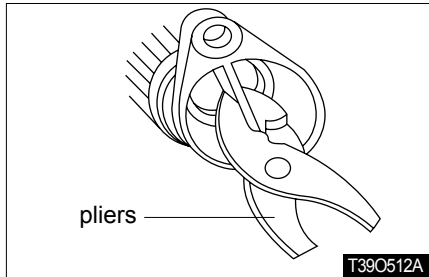

▶ REPLACING ENGINE OIL FILTER CARTRIDGE

- ① Remove the engine oil filter cartridge by turning it counterclockwise with a filter wrench.
- ② Apply a thin film of oil to the O-ring of a new cartridge and install the new cartridge by tightening it with a hand. When its packing touches the sealing surface, turn it approx. 2/3 turns further with a wrench.
- ③ Add engine oil to the specified level.

- ④ Run the engine for approx. 5 minutes and check for proper operation through the engine oil warning lamp. Then, stop the engine.

(This warning lamp should be turned off while the engine is running.)

- ⑤ Check the oil level with the dipstick again. If still insufficient, add more.



6. FUEL SYSTEM

► FUEL SYSTEM

Use only low sulfur or ultra low sulfur diesel fuel.

(1) Fuel tank



NOTE

- If foreign materials, such as dust and sand, or water are mixed in fuel, it can deteriorate the performance of the fuel injection pump. Make sure to add quality fuel through the strainer.



(2) How to bleed fuel system

It is necessary to bleed the system under the following conditions.

- The engine is stopped due to the empty fuel tank.
 - The filter or pipe is removed.
- ① Unscrew the bleeding screw.
 - ② Start the engine.
 - ③ When clean fuel flows out of the bleeding screw, tighten the screw.
 - ④ Repeat the procedure if the system is not bled completely.

(3) Fuel filter cleaning and element replacing

This filter is to remove foreign material and water from fuel.

- ① Set the fuel filter cock to the 'OFF' position.
- ② Loosen the ring screw on top of the cap to remove the cap. Then,
- ③ Flush the element with diesel fuel to remove any foreign material from it.
- ④ If the element is severely contaminated, replace it with a new one.

NOTE

- Clean or replace the fuel filter every 100 hours of operation.



MAINTENANCE AND SERVICE

7. CHECKING AND CLEANING AIR CLEANER

Check and clean the air cleaner according to the following instructions:



► VACUUM VALVE CLEANING

- Pull out the valve with a hand and remove dust from its inside. If it is dirty or watery, wipe it with a dry rag thoroughly before fitting it again.

< Cautions for inspection and service of air cleaner >

- (1) Use the standard element and filter and do not apply oil on them.
- (2) Remove any dust in the cover thoroughly.
- (3) Install it firmly so that dust does not enter below the cover.
- (4) Never drive with the element and filter removed.

► AIR CLEANER CLEANING

- ① Blow compressed air from the inside toward the outside of the element. Keep proper distance between the air nozzle and element.

► AIR CLEANER REPLACING

After cleaning the element 5 times or if it is damaged, replace it with a new one.

NOTE

- Do not hit the element with a rock or concrete during its cleaning.
- Make sure to install the element firmly.
- Tighten each part of the air cleaner securely to block dust completely.



8. GREASING

▶ GREASING POINTS

For general greasing points, refer to the fuel, oil and fluid specification chart. (See page 5-23.)

However, add grease before work if the Ride on lawnmower is to be used in a wet field.

▶ GREASING BRAKE ARM

Remove the rubber caps on the floor and dash panel to access to the grease nipple.

Add grease with the supplied grease gun.

9. CHECKING HOSES

Rubber parts, such as the fuel hose and radiator hose, are aged by time even when the Ride on lawnmower is not in use. Therefore, such parts should be replaced with their tightening bands every 2 years or when they are damaged.

⚠ WARNING

- If any fuel hose is damaged, fuel leaks and it can catch fire. Make sure to check the fuel hose and take a necessary action.



MAINTENANCE AND SERVICE

10. CHECKING ELECTRIC SYSTEM

▶ CHECKING AND CHARGING BATTERY

⚠ DANGER

- When charging the battery after removing it from the Ride on lawnmower, it produces hydrogen gas, presenting a fire risk. Charge the battery only in a well-ventilated area.
- The battery produces highly flammable hydrogen gas which can explode. Keep flammable items and spark away from the battery.
- The battery electrolyte is sulfuric acid so can burn your skin and eyes. Be careful not to spill any.

⚠ DANGER

- If the battery electrolyte gets on your eyes, skin, clothes or object, rinse it with water thoroughly. If you swallowed it, drink a lot of water. Also, get medical attention immediately if acid contacts your eye or is swallowed.



<Checking>

① Checking battery charging level

- If the battery is not used for over two weeks, it may become hard to start the engine. Charge the battery in this case.
- ② If the battery terminal is corroded, it cannot deliver current. If it is corroded or contaminated, wipe it with sandpaper or a brush.

BATTERY SPECIFICATION

12V 45AH (20HR)

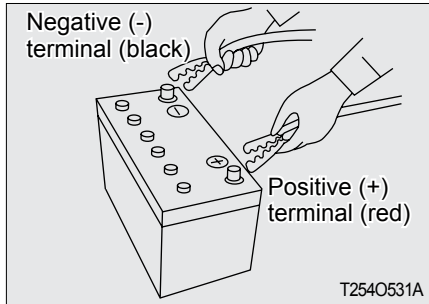

<Charging>

- ① Turn the ignition switch to the "OFF" position and remove the battery from the Ride on lawnmower.
- ② Charge the battery in a well-ventilated area.
- ③ Charge the battery with the normal procedures and avoid quick charging.
- ④ Turn the charger switch OFF and connect the cables to the negative and positive battery terminals correctly.
- ⑤ When using a charger, its charging current should be below 10 A.

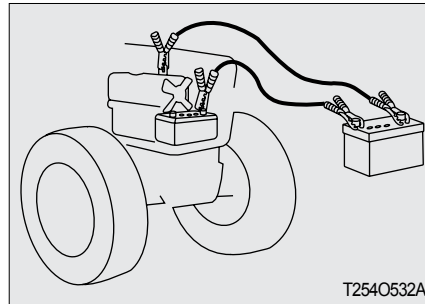

► JUMP START

- ① Turn off all electric devices.
- ② Connect the positive terminal of the normal battery to the positive terminal of the discharged battery with the jump cable.
- ③ Connect the negative terminal of the normal battery to the engine body of the Ride on lawnmower for the discharged battery with the jump cable.

- ④ Firstly, start the engine of the vehicle with the normal battery. Then, start the engine of the Ride on lawnmower with the discharged battery.
- ⑤ After the engine is started, disconnect the negative cable first. Then, disconnect the positive cable.
- ⑥ Charge the discharged battery for approx. 30 minutes after the engine is started.

⚠ WARNING

- Make sure to connect the positive terminal first and connect the negative terminal to the engine body of the Ride on lawnmower with the discharged battery.



MAINTENANCE AND SERVICE

▶ CHECKING ELECTRIC WIRING

- (1) Loose wiring terminals can cause contact failure and damaged wiring can lead to performance deterioration of electric devices, short circuit and fire. Replace or repair aged and damaged wirings.
- (2) If wiring sheath is peeled off, wrap wiring with insulating tape.
- (3) If fasteners or bands to fix wirings are damaged, fix wirings with clamps.
- (4) Have wiring checked by your workshop once a year regularly to avoid fire.

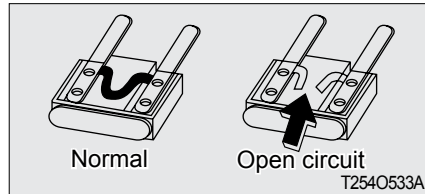

▶ CHECKING AND REPLACING FUSE

(1) Body fuse box

Fuses are installed in this Ride on lawnmower to prevent any possible accident in case of wiring circuit malfunction.

If the electric system is malfunctioning during driving, check for any blown fuse.

- ① Remove the cover of the fuse box.
- ② Remove the blown fuse.
- ③ Fit a new fuse with the same capacity.
- ④ The function and capacity of each fuse are indicated on the cover of the fuse box.

⚠ WARNING

- If using fuses other than the specified, wirings can be overheated, leading to a fire. Never use a fuse with different capacity. Also, never use a steel wire or foil instead of a fuse.

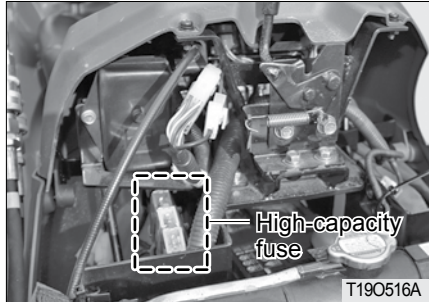

(2) High-capacity fuse (50 A)

This Ride on lawnmower is equipped with three fuses for wiring.

These fuses are blown to cut current to the electric circuit in order to protect wiring. Find the cause for blown fuses and replace them with the specified genuine parts.

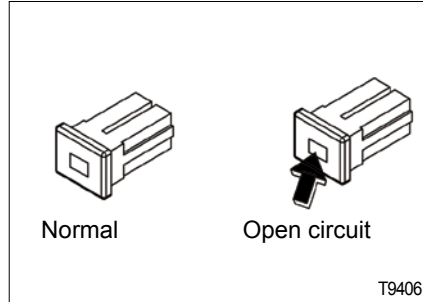

<Inspection>

Check the fuse through the transparent window to see if it is blown.

► REPLACING LAMP BULB

If a lamp does not come on by operating the corresponding switch:

- ① Check the corresponding fuse.
- ② If the fuse is intact, remove the bulb socket from the lamp.
- ③ Remove the bulb from the socket and check for blown filament.
- ④ If the filament is blown, replace the bulb with a new bulb with the same capacity.

BULB	SPECIFICATIONS
Headlamp	12V H8 35W
Turn signal lamp (Left)	12V 21W
Turn signal lamp (Right)	12V 21W
Position lamp	12V 5W



MAINTENANCE AND SERVICE

11. CHECK AND ADJUST EACH PART

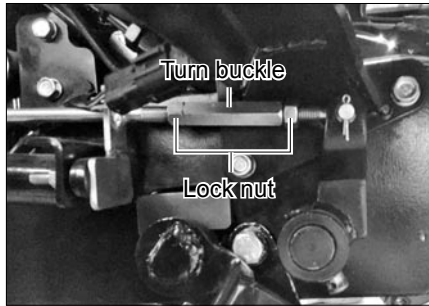

► CHECKING AND ADJUSTING BRAKE PEDAL

The brake pedal's play increases as it is used for an extended period of time. If its play is excessive, adjust it.

<Adjustment>

- ① Unscrew the lock nut and turn the adjusting nut to adjust the play (left and right).
- ② Turning it counterclockwise increases the play while turning it clockwise decreases the play.
- ③ After adjustment, tighten the lock nut firmly.

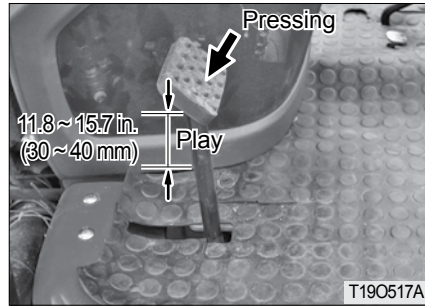

► BRAKE PEDAL PLAY

Depress the pedal lightly with a hand to check its play.

DIVISION	SPECIFIED VALUE
Play	11.8 ~ 15.7 in. (30 ~ 40 mm)

⚠ WARNING

- After adjustment, confirm the operating state.

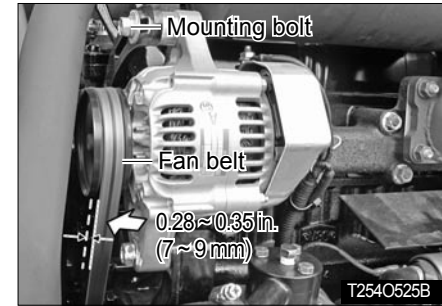

► CHECKING AND ADJUSTING FAN BELT

Check and adjust the fan belt's tension periodically.

- ① Unscrew the alternator mounting bolt slightly and move the alternator to adjust the tension.
- ② Check the belt's tension.
Press the middle of the belt with 13.2 ~ 15.4 lb (6 ~ 7 kg) of force. It is okay when the belt is deflected for 0.28 ~ 0.35 in. (7 ~ 9 mm).

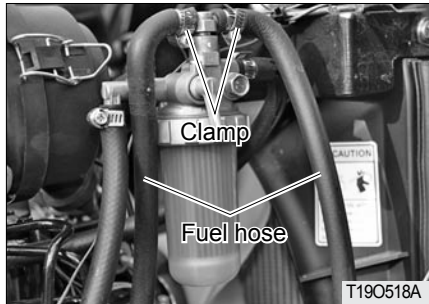

▶ FUEL HOSE CHECKING (MAIN FUEL FILTER)

Check the fuel hose as follows :

- ① Stop the engine. After the engine is sufficiently cooled down, open the hood.
- ② Check if the fuel hose is damaged or leaks. Replace it if necessary.
- ③ Tighten the clamp.

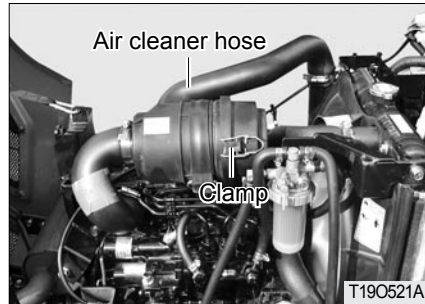

▶ AIR CLEANER HOSE CHECKING

Check the air cleaner hose as follows :

- ① Stop the engine. After the engine is sufficiently cooled down, open the hood.
- ② Check if the air cleaner hose is damaged or leaks. Replace it if necessary.
- ③ Tighten the clamp.

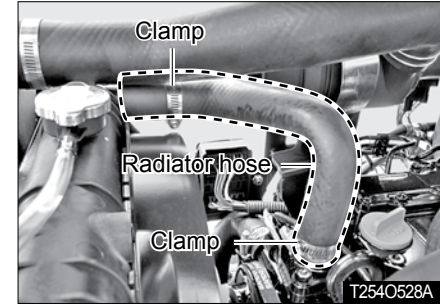

▶ RADIATOR HOSE CHECKING

Check the radiator hose as follows :

- ① Stop the engine. After the engine is sufficiently cooled down, open the hood.
- ② Check if the radiator hose is damaged or leaks. Replace it if necessary.
- ③ Tighten the clamp.



MAINTENANCE AND SERVICE

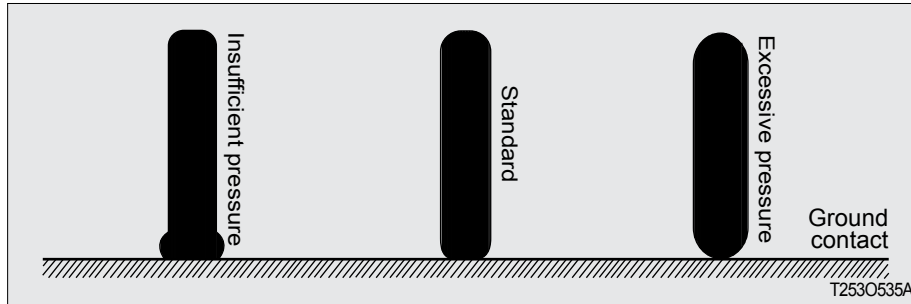

► TIRE INFLATION PRESSURE

Check if the inflation pressure of the front and rear tires is correct. If not, adjust it to the specification.

Tire Item	Standard Specifications	Pressure (kg/cm ²) / psi
	Turf Front	
Turf Rear	TURF R 24x12.00-12	1.4 / 20

WARNING

- Make sure to keep the specified inflation pressure of the tires to avoid an accident or even death due to tire's rupture.



12. ROUTINE MAINTENANCE SCHEDULE

▶ ROUTINE MAINTENANCE SCHEDULE

CAUTION

- Check or adjust each part only when the engine is stopped.
- When any hot part should be serviced, wait until it is cooled down.

○ : Check, Add, Adjust

△ : Clean, Wash

● : Change

★ : Service by workshop

Item	Inspection part	Hourmeter display													Remarks	Remarks page		
		Daily	50	100	150	200	250	300	350	400	450	500	550	600				
Engine	Engine oil & cartridge		●					●						●		Replace Every 250 hours or 12 months after first 50hours.	5-5, 9	
	Cleaning fuel filter and replacing element	○											●			Replace Every 1000 hours or 12 months.	5-11	
	Radiator coolant		Check every year and replace as necessary (check coolant level frequently)														5-4	
	Air cleaner element			△		△	○			△			●					5-12
	Fan belt		Check tension every 50 hours and replace as necessary														5-18	
	Battery		Check and replenish every 50 hours and replace as necessary														5-14	
	Radiator and air cleaner hoses and bands						○						○			Hoses Replace every 2 years	-	
	Checking fuel hose and band						○						○			Hoses Replace every 2 years	-	



MAINTENANCE AND SERVICE

○ : Check, Add, Adjust

△ : Clean, Wash

● : Change

★ : Service by workshop

Item	Inspection part	Hourmeter display												Remarks	Remarks page	
		50	100	150	200	250	300	350	400	450	500	550	600			
Body	Transmission Oil & HST Oil Filter	●										●		Replace Every 500 hours or 12 months after first 50 hours.	5-6	
	Front axle oil	●										●			5-8	
	Strainer	△						△							5-9	
	Toe-in						★						★	0.07 ~ 0.24 in. (2 ~ 6 mm)	-	
	Greasing each nipple	Add every 50 hours, daily if working in watery field													5-23	
	Brake pedal play	Check frequently before driving (check simultaneous operation of left and right parts)												Play: 11.8 ~ 15.7 in. (30 ~ 40 mm)	5-18	
	Tightness of front / rear wheels	Check frequently before driving													-	
	Adjusting throttle system						○							○		-
	Rubber hoses					○							○			-
	Checking electric wiring	○			○				○				○		Every year	-
Hydraulic hoses & pipes						○									-	



► FUEL, OIL AND FLUID SPECIFICATION CHART

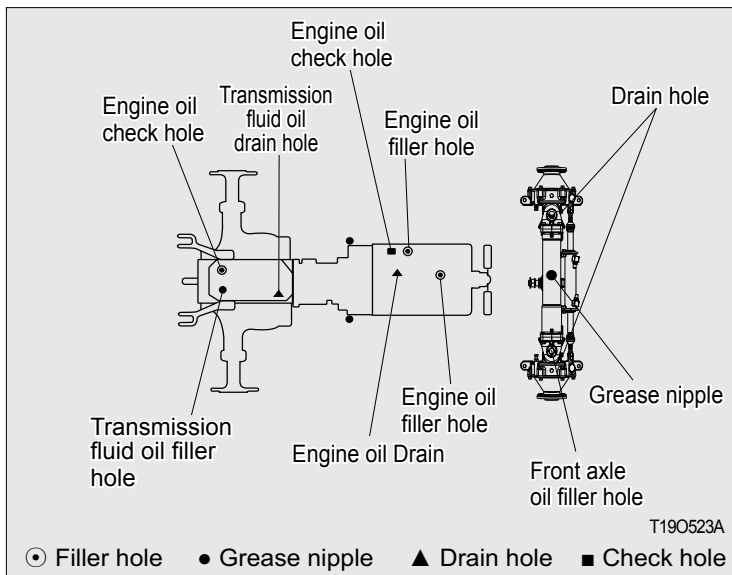

No.	Applied part	Oil	gal(ℓ)
			HST
1	Coolant	Antifreeze	0.9 (3.5)
2	Engine	Every 250 hours Engine Oil	0.53 (2)
3	Transmission fluid	THF 80W (API GL-4 Grade, Gear Oil 80W)	3.57 (13.5)
4	Front axle	Gear Oil API GL-4 SAE 90W	0.66 (2.5)
5	Fuel tank	Diesel fuel	6.6 (25)



STORAGE AND DISPOSAL

- 1. RIDE ON LAWNMOWER STORAGE 7-2
- 2. USAGE AND DISPOSAL 7-3

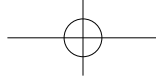

STORAGE AND DISPOSAL

1. RIDE ON LAWMOWER STORAGE

▶ DAILY STORAGE

- (1) Store the Ride on lawnmower after cleaning it. Especially, clean it thoroughly after harrowing or working in a wet field.
- (2) Make sure to lower an implement.
- (3) Store the Ride on lawnmower indoors if possible.
- (4) If storing the Ride on lawnmower outside, cover it.
- (5) For better startability, it is recommended to remove the battery from the Ride on lawnmower and keep it indoors in winter.
- (6) If the outside temperature is below 0 °C, add antifreeze or drain coolant completely to prevent the engine from freezing and bursting.
- (7) Remove the key and store it separately.

▶ LONG-TERM STORAGE

Clean the Ride on lawnmower thoroughly and store it as follows:

- (1) Change engine oil with new oil and run the engine for 5 minutes to distribute oil to each part evenly.
- (2) Drain coolant from the radiator. Then, make a label indicating "No Coolant" and fix it onto the steering wheel.
If antifreeze is already added, it is not necessary to drain coolant.
- (3) Add oil, fluid and fuel to each part according to the maintenance chart.
- (4) Apply a thin film of grease of oil to body parts that are apt to rust.
- (5) Check each bolt and nut for looseness and tighten any loose bolt and nut.
- (6) Set the tire inflation pressure a little higher than the specification.

- (7) Remove a weight. Detach or lower an implement.
- (8) Check the rear wheels.
- (9) Remove the battery from the Ride on lawnmower or turn off its switch to cut power connection.
- (10) Place wood blocks under the tires to protect them.
- (11) Charge the battery every 2 months during long-term storage.
- (12) Store it in a dry place to avoid rain or snow and cover the body.



▶ USE AFTER LONG-TERM STORAGE

Keep the following instructions when using the Ride on lawnmower after its long-term storage.

- (1) Inspect the Ride on lawnmower thoroughly before driving it.
- (2) To keep performance and life of the engine, idle the engine for approx. 30 minutes after starting it.

NOTE

- For engine lubrication, run the engine at 1,500 ~ 2,000 RPM for 5 to 10 minutes once a month.
- Remove the key from the Ride on lawnmower and store it separately.

CAUTION

- If leaving the battery connected to the Ride on lawnmower, turn off its switch to cut electric power.
- If wiring is damaged by rodents, its short circuit can start a fire.

STORAGE AND DISPOSAL

2. USAGE AND DISPOSAL

It is recommended to keep the followings to protect the environment:

- (1) Avoid overloading work as it can lead to incomplete combustion and emissions that can pollute the air.
- (2) When changing oil, including engine oil, transmission fluid, hydraulic oil and coolant, be careful not to spill it and discard used oil according to the applicable law.
Used oil should be treated with care and discarded properly as it can contaminate soil and water.
- (3) When this or other machine's life is expired, do not neglect or discard it on your own, but contact your dealer so that the approved service provider can discard the machine according to the laws.



TROUBLESHOOTING

- 1. ENGINE SYSTEM..... 8-2
- 2. BRAKE SYSTEM 8-6
- 3. STEERING SYSTEM 8-6
- 4. HYDRAULIC SYSTEM..... 8-7
- 5. ELECTRIC SYSTEM..... 8-8



TROUBLESHOOTING

1. ENGINE SYSTEM

	TROUBLE	PROBABLE CAUSE	SOLUTION
Engine	The start motor does not run even when turning the main switch.	<ul style="list-style-type: none"> • PTO switch set to ON position • Defective safety switch • Battery discharged • Loose terminal • Faulty switch • Defective start motor 	<ul style="list-style-type: none"> • Set the PTO switch to the OFF position • Have it repaired or replaced by workshop • Charge the battery • Check for looseness and corrosion. Clean, tighten and apply grease • Have it repaired or replaced by workshop • Have it repaired or replaced by workshop
	The start motor runs but its speed cannot be increased	<ul style="list-style-type: none"> • Weak battery • Poor ground • Incorrect viscosity of engine oil 	<ul style="list-style-type: none"> • Charge the battery • Clean the contact and connect the ground firmly • Change engine oil with proper viscosity
	The start motor runs but the engine cannot be started	<ul style="list-style-type: none"> • Air in fuel system • Clogged fuel filter • No delivery of fuel • Defective engine • Defective key stop unit 	<ul style="list-style-type: none"> • Bleed the system • Clean or replace the filter • Open the cock to add fuel • Have it repaired by workshop • Have it repaired by workshop
	The engine runs irregularly	<ul style="list-style-type: none"> • Air in fuel system • Clogged fuel filter 	<ul style="list-style-type: none"> • Bleed the system • Clean or replace the filter



TROUBLE		PROBABLE CAUSE	SOLUTION
Engine	The engine runs irregularly	• Clogged injection nozzle	• Have it repaired by workshop
		• Fuel leak at pipe	• Tighten the clamp, replace the pipe and machine and attach the copper washer
		• Poor fuel injection quality	• Have it repaired by workshop
	Engine stops at low speed	• Defective injection pump	• Have it repaired by workshop
		• Incorrect clearance of engine valve	• Have it repaired by workshop
		• Low idle speed	• Adjust it to the standard speed
		• Faulty nozzle	• Have it repaired by workshop
	The engine overruns	• Restricted governor	• Have it repaired by workshop
		• Oil rise	• Have it repaired by workshop
	The engine stalls suddenly	• Low fuel level	• Add fuel and bleed the system
		• Faulty nozzle	• Have it repaired by workshop
		• Engine seizure by insufficient oil or poor lubrication	• Have it repaired by workshop
The engine is over-heated	• Insufficient coolant amount	• Add coolant	
	• Damaged fan belt	• Replace the belt	
	• Clogged radiator	• Clean the radiator	
	• Insufficient engine oil	• Check and add	

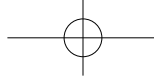

TROUBLESHOOTING

	TROUBLE	PROBABLE CAUSE	SOLUTION
Engine	The engine produces white smoke	• Clogged air cleaner	• Check and clean it
		• Excessive engine oil amount	• Check and set it to the proper amount
		• Insufficient fuel supply amount	• Have it repaired by workshop
	The engine produces black smoke	• Low quality fuel	• Add the specified fuel
		• Excessive fuel amount delivery	• Have it repaired by workshop
		• Insufficient nozzle pressure	• Have it repaired by workshop
	The engine does not produce sufficient power	• Clogged or carbon on nozzle tip	• Have it repaired by workshop
		• Insufficient compression or gas leak from valve seat	• Have it repaired by workshop
		• Improperly adjusted valve clearance	• Have it repaired by workshop
		• Incorrect injection timing	• Have it repaired by workshop
		• Low fuel level	• Add fuel
		• Clogged air cleaner	• Clean the element
	The oil warning lamp comes on during driving	• Low engine oil level	• Add to the specified level
• Low viscosity of engine oil		• Change engine oil with proper viscosity	
• Faulty pressure switch		• Replace the switch	



TROUBLESHOOTING



TROUBLE		PROBABLE CAUSE	SOLUTION
Engine	The oil warning lamp comes on during driving	• Defective oil pump	• Have it repaired by workshop
		• Clogged oil filter element	• Replace the oil filter
	The charge warning lamp comes on during driving	• Defective wiring	• Check for loose or missing terminal, short circuit and poor ground and repair as necessary
		• Defective alternator	• Have it repaired by workshop
		• Defective battery	• Replace the battery
	• Damaged fan belt	• Replace the belt	



TROUBLESHOOTING

2. BRAKE SYSTEM

TROUBLE		PROBABLE CAUSE	SOLUTION
Brake	The brake won't operate. Also, only one-side brake operates	• Excessive brake pedal play	• Adjust the play
		• Worn or burnt liner	• Have it repaired by workshop
		• Different play amount on left and	• Set the left and right play amount the same

3. STEERING SYSTEM

TROUBLE		PROBABLE CAUSE	SOLUTION
Steering system	The steering wheel feels heavy The steering wheel vibrates	• Improper toe-in	• Adjust
		• Incorrect tire inflation pressure	• Set the left and right tires to the same specified pressure
		• Vibration from each connection	• Tighten or replace connection
	The free movement of the steering wheel is excessive	• Worn steering wheel shaft	• Have it repaired by workshop
		• Worn metal parts	• Have it repaired by workshop
		• Free play from each connection	• Tighten



4. HYDRAULIC SYSTEM

	TROUBLE	PROBABLE CAUSE	SOLUTION
Hydraulic system	Oil leaks from the pipe or hose	• Loose clamp	• Tighten
		• Cracked pipe	• Have it replaced by workshop
	The hydraulic pressure won't be decreased	• Lowering speed control lever fixed to stop position	• Set it to the lowering position
		• Defective valve	• Have it repaired by workshop
		• Damaged cylinder	• Have it repaired by workshop
	The hydraulic pressure won't be increased	• Damaged and seized lift shaft rotating part	• Have it repaired by workshop
		• Insufficient engine RPM	• Set the speed to 1000 to 1500 RPM
		• Insufficient transmission fluid	• Add to the specified level
		• Air sucked into suction pipe	• Tighten the connection. If any pipe or hose is cracked or O-ring is damaged, replace it
		• Clogged oil filter	• Clean
		• Defective hydraulic pump	• Have it repaired by workshop
		• Defective valve	• Have it repaired by workshop
	• Damaged cylinder	• Have it repaired by workshop	



TROUBLESHOOTING

5. ELECTRIC SYSTEM

	TROUBLE	PROBABLE CAUSE	SOLUTION
Electric system	The battery won't be charged	• Blown fusible link	• Check the wiring and replace the fusible link
		• Defective wiring	• Check for loose or missing terminal, short circuit and poor ground and repair as necessary
		• Defective alternator	• Have it repaired by workshop
		• Loose or damaged fan belt	• Adjust the tension or replace the belt
		• Defective battery function	• Check for loose or corroded terminal and insufficient electrolyte and take any necessary action
Electric system	The headlamp does not produce enough light	• Low charging level of battery	• Charge
		• Contact failure in wiring	• Check, clean and re-tighten the ground and terminal
Electric system	The headlamp does not come on	• Blown bulb	• Replace the bulb
		• Blown fuse	• Check the wiring and replace the fuse
		• Contact failure	• Check and clean the ground and terminal
Electric system	The turn signal lamp does not blink	• Blown bulb	• Replace the bulb
		• Defective flasher unit	• Replace
		• Poor contact	• Check and clean the ground and terminal
	The work lamp does not come on	• Blown bulb	• Replace the bulb
• Contact failure		• Check and clean the ground and terminal	

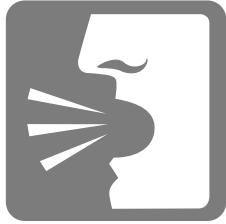

SAFETY STANDARD FOR FARM WORK

- 1. INSTRUCTION BEFORE USE..... 9-2**
- 2. CHECKUP LIST BEFORE OPERATION 9-3**
- 3. CAUTIONS DURING THE WORK 9-4**
- 4. CAUTIONS WHEN DRIVING ON THE FARM ROAD 9-5**
- 5. INSTRUCTION AFTER USE 9-6**
- 6. CAUTIONS FOR INSPECTION AND MAINTENANCE... 9-6**
- 7. RIDE ON LAWNMOWER..... 9-7**



SAFETY STANDARD FOR FARM WORK

SAFETY MARK

Excerpted from general information system of agricultural mechanic research center (August, 2002) 8.)

Agricultural Mechanic Research Center, an affiliation of Ministry of Agriculture and Forestry stipulated "safety instructions" when working with agricultural equipment for safety purpose.

Please read carefully the contents as the user's manual. Try to work safely.

- Always make sure to check the operating condition of the safety lamp (such as turn signal lamp) before operating the machine.

※ If any lighting system is removed ※

- It may lead to an unexpected accident because it is not possible to give signals to people or machine nearby.

1. INSTRUCTION BEFORE USE

- Operator must attend his/her health and should get enough rest.
- Before using the machine, check it and repair if there is a malfunction.
 - Check if the assembly of front and rear wheels is okay.
 - Check the tightening of bolts and nuts in each unit.
- Do not drive if you are mentally unstable, drunk, pregnant, under the age of 16, not trained, overworked, sick, under the influence of drugs, and any other reason that may affect normal operation of the machine.
- Please wear the appropriate working clothing.
 - Put on a hard hat to protect your head.
 - Put on a hat and a working clothes, to prevent an injury such as being twined into the machine.
 - Protective measures to prevent any injury on foot or slipping - Put on an appropriate non-slippery shoes to prevent a fall from the machine, scattering soil, and slippery surface.
 - Measures against dust and toxic gas.
 - Wear an appropriate protective gear.
 - Measures against the herbicide – wear protective gear to protect respiratory system, eyes and skin.



SAFETY STANDARD FOR FARM WORK

2. CHECKUP LIST BEFORE OPERATION

- Measures against noise – wear a protective gear to protect your ears.
- Handling protective gear – Do neither let children get on the machine nor get close to the machine.
- If it is not possible to park the agricultural machine on a road either due to a breakdown or any other reason, operator must take an action such as moving the equipment to a place other than a road.
- Also, put a signal that there is a broken car, 100m behind and 200m at night in accordance with Automobile Regulation Article 23.
- When starting to drive, make sure to check around carefully.
 - Do not let anyone such as a child get close to the machine, keep them away and then drive the machine.
- Do not load flammable, explosive material (diesel, gasoline, etc) on the machine.
- When getting on and off a truck, have a helper give you signal and follow his/her lead.
- Refer to chapter 1 in user's manual regarding the decals on the machine.
- Before using the machine, check it and repair if there is a malfunction.
- Check engine oil.
 - Pull out level gauge, wipe off any fuel leak, put it back in, and pull it out again to see if the oil level is between 「upper limit」 and 「lower limit」.
- Before any operation, check for any foreign materials caught on the engine, muffler, battery, and the fuel tank. Remove them immediately.
- Covers that are removed during the maintenance work should be reinstalled to their original positions.
 - Attach the cover correctly and firmly.



SAFETY STANDARD FOR FARM WORK

3. CAUTIONS DURING THE WORK

- Do not load anything that can interfere driving.
 - Always keep the driver's seat clean.
- Always buckle up when driving.
- Opening radiator cap when heated can spring out the steam to have the operator burned. Open the cap after it is sufficiently cooled down.
- Do not drive with depressing the differential gear pedal.
- Prohibit anyone to get on the machine.
 - Prohibit anyone to get on the machine other than the designated place.
 - Even though there are some designated place, do not let people more than capacity get on the machine.
 - Never let any passenger mount on the machine. Also, do not put any object on the machine. Keep people away from the machine.
 - Do not jump on/off the operating machine except for emergency.
- Be cautious not to let anyone touch the belt . Always check the connected area of belt.
- When two people are working collaboratively, exchange signals each other.
- Prevent injury
 - Do not touch power transmission gear, rotating unit, and other dangerous parts.
 - Pay special attention if you are working with the machine with blade or sharp projection
 - Be careful not to injure from the work where soils and stones are scattered around.
- Safety in inspection, adjustment, etc.
 - Make sure to stop the motor and carry out the work in a safe environment.
 - When leaving the machine for a break, or other reason, leave the machine in a safe place and descend the working unit to keep them in a safe stopped state.
- Removing and installing should be carried out in a safe place and with a safe method.
- Do neither stay nor insert foot under the working units.



4. CAUTIONS WHEN DRIVING ON THE FARM ROAD

- Driving on roads
 - Drive safely observing the relevant regulation.
 - Drive at safe speed.
 - Be careful not to disturb other drivers.
 - When driving a machine with sharp blade or bump, put on a warning sign or detach in advance to prevent any injury.
 - Do not drive fast particularly on winding roads with projecting rocks.
 - When driving at night, do not detach lighting device. (headlight, turn indicator, work light, brake light, etc)
 - Do not drive fast, abrupt starting, abrupt acceleration, sudden stop, and quick turning.
 - When driving at high speed, do not slam on the brake. Never slam on the brake especially when turning at high speed.
- When loading/unloading the machine
 - Choose a place with a leveled and safe ground.
 - Drive at low speed.
 - Use a ramp with anti-slippery.
- When entering paved road
 - Use a ramp to cross a ditch or a bank.
 - Make sure to use a ramp to enter/exit a high foot-path. Be careful with fall and not to overturn.
 - Check the safety around the surrounding before starting to drive.
- When driving on a slope
 - Drive at the minimum speed, lower the operating machine as low as possible and low the center position.



SAFETY STANDARD FOR FARM WORK

5. INSTRUCTION AFTER USE

- When the work is completed, stop the engine on a leveled ground, check the machine to clean. (remove any foreign materials)
 - Remove straws, dirt, etc and clean around the engine, silencer, and fuel tank.
- Lay a cover on the transplanter (equipment) after the muffler and engine cool down.
- Get a regular inspection after the season is over.
 - When discarding a part (battery, oil, etc) or scrap a machine, consult to a dealer and proceed accordingly.
- For long-term storage, remove the battery from the machine and store it or disconnect the negative battery cable.

6. CAUTIONS FOR INSPECTION AND MAINTENANCE

- Do not refuel either when the engine is still hot or while driving.
- Measures against a fire: Every working place with a risk of fire should be provided with a fire extinguisher. Prevent a fire by taking measures such as making a smoking area.
- Always wipe off the leaked fuel.
- Be seated in the cab when starting the engine.
- After refueling, tighten the fuel cap and check if there is any fuel leakage from tank or pipe.
- When opening a cap to supply water to radiator, be careful because steam or boiling water may spray due to overheating.
- When getting off the cab, turn off the engine, lock the parking brake and remove the ignition key.
- If it is inevitable to park on a slope, choke the wheels.
- Park on a leveled and safe ground safely.
- Check if the wiring code is in contact with other parts, peeled, loose or having spacing.



7. RIDE ON LAWNMOWER

- Manage PTO
 - Stop PTO before stopping the engine.
 - Do not remove the PTO protective cover or protective panel for operating machine.
 - Do not use PTO adaptor in order to extend the POT coupler or universal joint to outside of PTO protective cover.
- To repair, secure the wheel width, or changing the wheel under either Ride on lawnmower or trailer, with the Ride on lawnmower or trailer raised, choke the wheels that are on the ground.
- Do not use hydraulic jack for operating machine or Ride on lawnmower. Instead, use block or stand.
- Safety frame
 - Do neither weld nor drill a hole on the attached safety frame. Also do not modify it.
 - Replace the damaged safety frame with a new one.
 - If the safety frame was removed for specialized work, restore it immediately.
- Be careful to touch dangerous area such as power transmission gear, rotating unit, etc. Put on a protective cover.
- Do neither modify nor remove the safety device.



APPENDIX

1. MAJOR SPECIFICATIONS..... 10-2

2. MAJOR CONSUMABLES 10-4



APPENDIX

1. MAJOR SPECIFICATIONS

MODEL	T194	
Engine	Engine Manufacturer	Yanmar
	Engine Model	3TNV74F-SDKTF2
	Engine Type	Natural Aspiration
	Engine HP-Gross	19 [14.2]
	Rated engine speed	3,000
	Number of cylinders	3
	Displacement-cu.in.[cc]	60.6 [993]
	Air Cleaner	Single Dry
	Alternator	12V 40A
	Fuel System Type	Indirect Fuel Injection
Powertrain	Transmission type	HST
	Number of Speeds	2 Range
	Max Travelling Speed, mph[km/h]	7.8 [12.5]
	Brakes	Wet Disc
	Steering	Hydrostatic

MODEL	T194	
Hydraulic System	Pump Type	Single Gear Pump with Flow Divider
	Implement pump cap.gpm [L/Min]	4.17 [15.8]
	Steering pump cap.gpm [L/Min]	2.11 [8]
	Max Total flow gpm [L/Min]	6.97 [26.4]
	Lift Control Type	Position
	PTO	PTO Type
PTO Control		Electric/Hydro
PTO Mid-Option [rpm]		2,500
PTO Shaft Diameter in.[mm]		1 3/8 [35]



MODEL	T194		
Capacities	Fuel Tank	U.S gal.[L]	6.6 [25]
	Cooling system	U.S qt.[L]	3.7 [3.5]
	Crankcase [witd filter]	U.S qt.[L]	2.1 [2]
	Trans & Hyd. System,	U.S gal.[L]	3.6 [13.5]
	Front Axle	U.S qt.[L]	2.6 [2.5]
Dimensions	Overall length	in. [mm]	94.2[2,062]
	Overall with	in. [mm]	44.5 [1,135]
	Wheelbase	in. [mm]	53.1 [1,360]
	Height to top of ROPS,	in. [mm]	86.6 [2,200]
ROPS & Standard Tires	Turf	Front	TURF F16X7.50-8
		Rear	TURF R24X12.00-12
ROPS & Weight	Rollover Protection Standard		ROPS
	Total Weight.	lb [kg]	1,671 [758]



APPENDIX

2. MAJOR CONSUMABLES

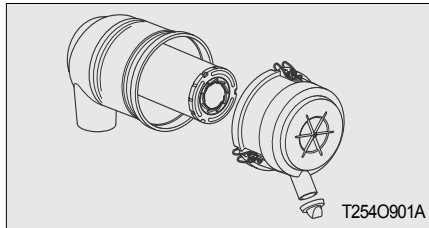

Element SET

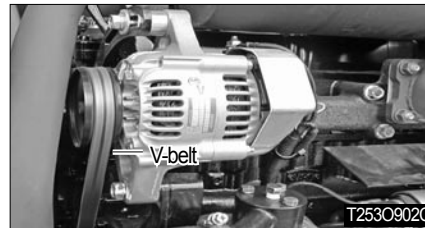

V-belt



Fuel filter

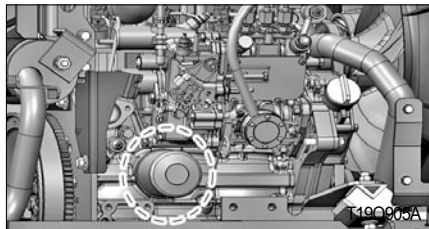

Engine oil filter



Filter Cartridge



Transmission Strainer

No.	NAME	QAUNTITY	APPLICATION
1	Element assembly	1	Air cleaner
2	V-belt	1	Engine fan belt
3	Main Fuel filter	1	Fuel filter
4	Pre Fuel filter	1	Fuel Filter
5	Engine oil filter	1	Engine oil filter
6	Filter cartridge	1	Transmission hydraulic oil
7	Strainer	1	Transmission element

10 - 4

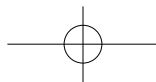



INDEX

1. INDEX.....11-2



INDEX

A

ADJUSTING FRONT AND REAR CUTTING HEIGHT	3-23
ADJUSTING LEFT AND RIGHT CUTTING HEIGHT	3-24
ADJUSTING MOWER LINK	3-22
AIR CLEANER CLEANING	6-12
AIR CLEANER HOSE CHECKING	6-19
AIR CLEANER REPLACING	6-12
APPENDIX	10-1
ASSISTANCE IN USING THIS MANUAL	3-2

B

BELT REPLACEMENT	3-28
BELT REPLACEMENT	3-29
BLADE INSTALLATION	3-28
BLADE REMOVAL	3-27
BRAKE PEDAL PLAY	6-18
BRAKE PEDEL	2-13
BRAKE SYSTEM	8-6

C

CAUTIONS DURING THE WORK	9-4
CAUTIONS FOR DRIVING INTO / OUT OF FIELD	4-6
CAUTIONS FOR DRIVING ON ROAD	4-7
CAUTIONS FOR INSPECTION AND MAINTENANCE	9-6

CAUTIONS WHEN DRIVING ON THE FARM ROAD	9-5
CHARGING	4-7
CHECK AND ADJUST EACH PART	6-18
CHECKING AND ADJUSTING BRAKE PEDAL	6-18
CHECKING AND ADJUSTING FAN BELT	6-18
CHECKING AND CHANGING ENGINE OIL	6-5
CHECKING AND CHANGING FRONT AXLE OIL	6-8
CHECKING AND CHANGING OIL	6-5
CHECKING AND CHANGING TRANSMISSION FLUID	6-6
CHECKING AND CHARGING BATTERY	6-14
CHECKING AND CLEANING AIR CLEANER	6-12
CHECKING AND REPLACING FUSE	6-16
CHECKING ELECTRIC SYSTEM	6-14
CHECKING ELECTRIC WIRING	6-16
CHECKING HOSES	6-13
CHECKUP LIST BEFORE OPERATION	9-3
CLEANING RADIATOR AND RADIATOR GRILLES	6-4
COMBINATION SWITCH	2-5
CONTROLLING	2-21
COOLANT TEMPERATURE LAMP	2-4
CRUISE CONTROL SWITCH	2-11

D

DAILY STORAGE	7-2
---------------------	-----



INDEX



DESCRIPTION OF RIDE ON LAWNMOWER CONTROLS ..2-1
 DIFFERENTIAL LOCK PEDAL..... 2-15
 DRIVING ON SLOPE 4-5
 DRIVING SPEED CONTROL PEDAL 2-13

E

ELECTRIC SYSTEM..... 8-8
 ENGINE COOLANT 4-7
 ENGINE COOLANT INSPECTION AND CHANGE..... 6-4
 ENGINE IDLING 4-3
 ENGINE IDLING IN COLD CONDITION 4-3
 ENGINE OIL PRESSURE 4-7
 ENGINE STARTING 4-2
 ENGINE STOPPING 4-3
 ENGINE SYSTEM 8-2
 EXTRRIOR VIEW..... 1-2

F

FILLING DIAGRAM AND SERVICE INTERVALS 3-11
 FRONT LINK 3-21
 FRONT WHEEL DRIVE LEVER (4WD) 2-16
 FUEL GAUGE 2-4
 FUEL HOSE CHECKING (MAIN FUEL FILTER)..... 6-19
 FUEL SYSTEM..... 6-11

FUEL SYSTEM..... 6-11
 FUEL, OIL AND FLUID SPECIFICATION CHART 6-23

G

GEAR BOX..... 3-29
 GENERAL ENGINE IDLING..... 4-3
 GENERAL INFORMATION..... 1-1
 GENERAL OPERATION..... 3-5
 GREASING..... 6-13
 GREASING BRAKE ARM 6-13
 GREASING POINTS 6-13

H

HAZARD FLASHER SWITCH 2-6
 HOUR METER 2-4
 HOW TO START ENGINE..... 4-2
 HYDRAULIC LOWERING SPEED CONTROL KNOB 2-20
 HYDRAULIC SYSTEM..... 8-7

I

IMPLEMENT LIFT CONTROL SYSTEM 2-20
 INDEX..... 11-1
 INFORMATIONAL DECALS 3-14
 INSPECTING AND CHANGING COOLANT 6-4



INDEX

I

INSPECTION ITEMS.....	6-2
INSPECTION ITEMS.....	6-2
INSTRUCTION AFTER USE.....	9-6
INSTRUCTION BEFORE USE.....	9-2
INSTRUMENT AND SWITCHES.....	2-2

J

JUMP START	6-15
------------------	------

L

LOADING TO / UNLOADING FROM TRUCK.....	4-6
LONG-TERM STORAGE	7-2
LUBRICATION.....	3-18

M

MACHINE USE	3-2
MAIN SWITCH	2-3
MAINTENANCE	6-1
MAINTENANCE(1).....	3-9
MAINTENANCE(2).....	3-11
MAJOR CONSUMABLES	10-4
MAJOR SPECIFICATIONS	10-2
METRIC FASTENER(ISO) TORQUE CHART.....	3-26

MID MOWER SPECIFICATION	3-16
MONITOR LAMP	2-7
MOUNTING FRONT LINK.....	3-21
MOWER ADJUSTMENT	3-22

O

OPENING COVERS.....	6-2
OPENING HOOD	6-2
OPERATING TIPS FOR POWER STEERING WHEEL	2-19
OPERATION.....	4-1
OPERATION CHECK DURING DRIVING.....	4-7
OPERATION THE CONTROLS	2-12
OPERATION(1)	3-7
OPERATION(2)	3-8

P

PARKING BRAKE PEDAL.....	2-14
PRECAUTIONS FOR HANDLING IMPLEMENT	5-2
PREFACE.....	3-2
PTO	2-18
PTO ON/OFF SWITCH	2-11

R

RADIATOR HOSE CHECK-ING.....	6-19
------------------------------	------



INDEX



REAR LINK.....	3-20
REPLACEMENT.....	3-27
REPLACING ENGINE OIL FILTER CARTRIDGE.....	6-10
REPLACING FILTER AND CARTRIDGE.....	6-9
REPLACING LAMP BULB.....	6-17
REPLACING TRANSMISSION FLUID FILTER CARTRIDGE.....	6-9
RIDE ON LAWNMOWER.....	9-7
RIDE ON LAWNMOWER STORAGE.....	7-2
ROUTINE MAINTENANCE SCHEDULE.....	6-21
ROUTINE MAINTENANCE SCHEDULE.....	6-21
RUNNING-IN PERIOD.....	4-4
S	
SAFETY DECALS.....	3-13
SAFETY MARK.....	9-2
SAFETY SIGNS.....	1-5
SAFETY STANDARD FOR FARM WORK.....	9-1
SEAT AND SAFETY BELT.....	2-17
SETTING MOWERS.....	3-19
SLOPE OPERATION.....	3-6
STARTING OFF.....	4-4
STARTING OFF ON STEEP SLOPE.....	4-5
STARTING OFF, SHIFTING AND DRIVING.....	4-4
STEERING SYSTEM.....	8-6

STOPPING.....	4-3
STOPPING AND PARKING.....	4-4
STORAGE AND DISPOSAL.....	7-1
SUB SHIFT LEVER.....	2-14
T	
TACHOMETER.....	2-3
THE MOWER.....	3-4
THE TRACTOR.....	3-3
THROTTLE LEVER.....	2-13
TIPS FOR DRIVING ON SLOPE.....	4-5
TIRE INFLATION PRESSURE.....	6-20
TRANSMISSION STRAINER CLEANING.....	6-9
TRANSPORTATION.....	3-6
TROUBLESHOOTING.....	8-1
U	
UNIVERSAL JOINT.....	3-19
USAGE AND DISPOSAL.....	7-3
USE AFTER LONG-TERM STORAGE.....	7-3
V	
VACUUM VALVE CLEANING.....	6-12

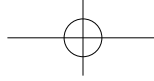

INDEX

W

WARRANTY12-1
 WORK PROCEDURE5-1



WARRANTY

WARRANTY

PDI CHECKLIST



WARRANTY

YANMAR WARRANTIES

■ YANMAR LIMITED WARRANTY

What is Covered by this Warranty?

YANMAR warrants to the original retail purchaser that a new YANMAR TNV common rail series industrial engine will be free from defects in material and/or workmanship for the duration of the warranty period.

Note: YANMAR engines may be equipped with external components including, but not limited to: wiring harnesses, electrical devices, control panels, radiators, air filters, fuel filters, and/or exhaust systems that are supplied and/or installed by manufacturers other than YANMAR. For warranty information on such external components, please contact the machine or component manufacturer directly or see your authorized YANMAR dealer or distributor.

This warranty is provided in lieu of all other warranties, express or implied. YANMAR specifically disclaims any implied warranties of merchantability or fitness for a particular purpose, except where such disclaimer is prohibited by law. If such disclaimer is prohibited by law, then implied warranties shall be limited in duration to the life of the express warranty.

How Long is the Warranty Period?

The YANMAR standard limited warranty period runs for a period of twenty-four (24) months or two-thousand (2000) engine operation hours, whichever occurs first. An extended limited warranty of thirty-six (36) months or three thousand (3000) engine operating hours, whichever occurs first, is provided for these specific parts only: the cylinder block, cylinder head, crankshaft forging, connecting rods, flywheel, flywheel housing, camshaft,



WARRANTY



timing gear, and gear case. The warranty period for both the standard limited warranty and the extended limited warranty (by duration or operation hours) begins on the date of delivery to the original retail purchaser and is valid only until the applicable warranted duration has passed or the operation hours are exceeded, whichever comes first.

What is not Covered by this Warranty?

This warranty does not cover parts affected by or damaged by any reason other than defective materials or workmanship, including, but not limited to, accident, misuse, abuse, "Acts of God," neglect, improper installation, improper maintenance, improper storage, the use of unsuitable attachments or parts, the use of contaminated fuels, the use of fuels, oils, lubricants, or fluids other than those recommended in your YANMAR Operation Manual, unauthorized alterations or modifications, ordinary wear and tear, and rust or corrosion. This warranty does not cover the cost of parts and/or labor required to perform normal/scheduled maintenance on your YANMAR engine. This warranty does not cover consumable parts such as, but not limited to, filters, belts, hoses, fuel injector, lubricants and cleaning fluids. This warranty does not cover the cost of shipping the product to or from the warranty repair facility.

Warranty Limitations:

The foregoing is YANMAR's only obligation to you and your exclusive remedy for breach of warranty. Failure to follow the requirements for submitting a claim under this warranty may result in a waiver of all claims for damages and other relief. In no event shall YANMAR or any authorized industrial engine dealer or distributor be liable for incidental, special or consequential damages. Such consequential damages may include, but not be limited to, loss of revenue, loan payments, cost of rental of substitute equipment, insurance coverage, storage, lodging,

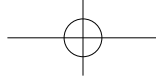

WARRANTY

transportation, fuel, mileage, and telephone costs. The limitations in this warranty apply regardless of whether your claims are based on breach of contract, tort (including negligence and strict liability) or any other theory. Any action arising hereunder must be brought within one (1) year after the cause of action accrues or it shall be barred. Some states and countries do not allow certain limitations on warranties or for breach of warranties. This warranty gives you specific legal rights, and you may also have other rights which vary from state to state and country to country. Limitations set forth in this paragraph shall not apply to the extent that they are prohibited by law.

Warranty Modifications:

Except as modified in writing and signed by the parties, this warranty is and shall remain the complete and exclusive agreement between the parties with respect to warranties, superseding all prior agreements, written and oral, and all other communications between the parties relating to warranties. No person or entity is authorized to give any other warranty or to assume any other obligation on behalf of YANMAR, either orally or in writing.

Questions:

If you have any questions or concerns regarding this warranty, please call or write to the nearest authorized YANMAR industrial engine dealer or distributor or other authorized facility.



■ EMISSION SYSTEM WARRANTY

YANMAR CO., LTD. EMISSION CONTROL SYSTEM WARRANTY- USA ONLY

Your Warranty Rights and Obligations:

The California Air Resources Board (CARB), the United State Environmental Protection Agency (EPA) and YANMAR CO., LTD. hereafter referred to as YANMAR, are pleased to explain the emission control system warranty on your industrial compression-ignition engine. In California, model year 2000 or later off-road compression-ignition engines must be designed, built and equipped to meet the State's stringent anti-smog. In all states, 1998 and later non-road compression-ignition engines must be designed, built and equipped to meet the United States EPA emissions standards. YANMAR must warrant the emission control system on your engine for the periods of time listed below provided there has been no abuse, neglect or improper maintenance of your engine.

Your emission control system may include parts such as the fuel injection system, the air induction system, the electronic control system, EGR (Exhaust Gas Recirculation) system and the diesel particulate filter system. Also included may be hoses, belts, connectors and other emission-related assemblies.

Where a warrantable condition exists, YANMAR will repair your off-road compression-ignition engine at no charge to you including diagnosis, parts and labor.

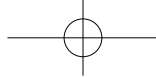

WARRANTY

Manufacturer's Warranty Period:

The model year 1998 or later certified and labeled non-road compression-ignition engines are warranted for the periods listed below. If any emission-related part on your engine is found to be defective during the applicable warranty period, the part will be replaced by YANMAR.

If your engine is certified as	And its maximum power is	And its rated speed is	Then its warranty period is
Variable speed or constant speed	kW < 19	Any speed	1.500 hours or two (2) years whichever comes first. In the absence of a device to measure the hours of use, the engine has a warranty period of two (2) years.
Constant speed	$19 \leq \text{kW} < 37$	3,000 rpm or higher	1.500 hours or two (2) years whichever comes first. In the absence of a device to measure the hours of use, the engine has a warranty period of two (2) years.
Constant speed	$19 \leq \text{kW} < 37$	Less than 3,000 rpm	3.000 hours or five (5) years whichever comes first. In the absence of a device to measure the hours of use, the engine has a warranty period of five (5) years.
Variable speed	$19 \leq \text{kW} < 37$	Any speed	3.000 hours or five (5) years whichever comes first. In the absence of a device to measure the hours of use, the engine has a warranty period of five (5) years.
Variable speed or constant speed	$\text{kW} \geq 37$	Any speed	3.000 hours or five (5) years whichever comes first. In the absence of a device to measure the hours of use, the engine has a warranty period of five (5) years.

**Warranty Coverage:**

This warranty is transferable to each subsequent purchaser for the duration of the warranty period. Repair or replacement of any warranted part will be performed at an authorized YANMAR or distributor.

Warranted parts not scheduled for replacement as required maintenance in the owner's manual shall be warranted for the warranty period. Warranted parts scheduled for replacement as required maintenance in the owner's manual are warranted for the period of time prior to the first scheduled replacement. Any warranted parts scheduled for replacement as required maintenance that are repaired or replaced under warranty shall be warranted for the remaining period of time prior to the first scheduled replacement. Any part not scheduled for replacement that is repaired or replaced under warranty shall be warranted for the remaining warranty period.

During the warranty period, YANMAR is liable for damages to other engine components caused by the failure of any warranted part during the warranty period.

Any replacement part which is functionally identical to the original equipment part in all respects may be used in the maintenance or repair of your engine, and shall not reduce YANMAR's warranty obligations.

Add-on or modified parts that are not exempted may not be used. The use of any non-exempted add-on or modified parts shall be grounds for disallowing a warranty.

Warranted Parts:

This warranty covers engine components that are a part of the emission control system of the engine as delivered by YANMAR to the original retail purchaser. Such components may include the following:

- (A) Fuel injection system
- (B) Electronic control system
- (C) Cold start enrichment system



WARRANTY

- (D) Intake manifold
- (E) Turbocharger systems
- (F) Exhaust manifold
- (G) EGR system
- (H) Positive crankcase ventilation system
- (I) Hoses, belts, connectors and assemblies associated with emission control systems

Since emissions related parts may vary slightly between models, certain models may not contain all of these parts and other models may contain the functional equivalents.

Exclusions:

Failures other than those arising from defects in material or workmanship are not covered by this warranty. The warranty does not extend to the following: malfunctions caused by abuse, misuse, improper adjustment, modification, alteration, tampering, disconnection, improper or inadequate maintenance, or use of non-recommended fuels and lubricating oils; accident-caused damage and replacement of expendable items made in connection with scheduled maintenance. YANMAR disclaims any responsibility for incidental or consequential such as loss of time, inconvenience, loss of use of equipment/engine or commercial loss.

**Owner's Warranty Responsibilities:**

As the off-road compression-ignition engine owner, you are responsible for the performance of the required maintenance listed in your owner's manual. YANMAR recommends that you retain all documentation, including receipts, covering maintenance on your off-road compression-ignition engine, but YANMAR cannot deny warranty solely for the lack of receipts, or for your failure to ensure the performance of all scheduled maintenance.

YANMAR may deny your warranty coverage if your off-road compression-ignition engine or a part has failed due to abuse, neglect, improper maintenance or unapproved modifications.

Your engine is designed to operate on diesel fuel only. Use of any other fuel may result in your engine no longer operating in compliance with GARB and EPA emissions requirements.

You are responsible for initiating the warranty process. You must present your engine to a YANMAR dealer as soon as a problem exists. The warranty repairs should be completed by the dealer as expeditiously as possible. If you have any questions regarding your warranty rights and responsibilities, or would like information on the nearest YANMAR dealer or authorized service center, you should contact YANMAR America Corporation.

Website: www.yanmar.com

E-mail: CS_support@yanmar.com

Toll free telephone number: 1-800-872-2867, 1-855-416-7091



WARRANTY

■ EMISSION-RELATED INSTALLATION INSTRUCTIONS (REF)

Failing to follow these instructions when installing a certified engine in a piece of non-road equipment violates Federal Law (40 CFR1068.105(8)), subject to fines or other penalties as described in the clean air act.

Installation of Non-road Engines into Equipment

To ensure engines operate under the certified configurations, YANMAR has established defined application requirements when installing any certified engine into a piece of equipment. The instructions outlined below are included in our certification process and any failure to comply will be considered tampering.

YANMAR certifies engines to operate under variable speed or constant speed conditions. Engines certified as constant speed are prohibited from installation into variable speed applications. The emission control information label will identify an engine certified as constant speed.

Allowable Air Intake Restriction and Exhaust Back Pressure

Resistance to intake airflow and exhaust gas flow is generated in the intake and exhaust systems.

Exceeding the limitations will affect the operation of an engine and its certified configuration. Refer to the installation requirements and limitations of the TNV series Application Manual for the engine being equipped with these systems.



Allowable Air Intake Restriction

Engine model	Allowable air intake restriction ≤ kPa (mmAq)	
	Initial upper limit	Upper limit for air cleaner replacement
All TNV models	2.94 (300)	6.23 (635)

Allowable Exhaust Back Pressure

Engine model	Allowable air intake restriction ≤ kPa (mmAq)	
	Initial upper limit	Upper limit for exhaust system cleaning
All models (3TNV74F)	9.81 (1,000)	11.77 (1,200)

In-Use Testing Requirements

Exhaust systems should be designed so that a 20 cm (7.87 in.) extension can be installed to the end of the exhaust pipe for purposes of sampling emissions. For equipment that does not allow installation of an extension pipe, a connection must be designed into the exhaust system for temporary attachment of exhaust sampling equipment. An example of an approved connection would be internally threaded with standard pipe threads of a size not larger than one-half inch, and shall be closed by a pipe-plug when not in use.



WARRANTY

Emission Control Label

If you install the engine in a way that makes the engine's emission control information label hard to read during normal engine maintenance, you must place a duplicate label on the equipment, as described in 40 CFR 1068.105.

Fuel Inlet Label

Unless otherwise specified, YANMAR will also provide a supplemental fuel inlet label with each certified engine for installation on the equipment. Permanently attach this label to the equipment near the fuel inlet.

Installation Evaluation

YANMAR CO., LTD. and its regional headquarters will determine approval of applications to the guidelines of the Application Manual, including these Emission-Related Installation Instructions.

To ensure engine performance and exhaust emissions compliance YANMAR will review net rated output based on engine build, intake air restriction, exhaust back pressure, engine heat balance and any other operational characteristic required under the Engine Installation Evaluation process.

Engine Maintenance

Equipment manufacturers are responsible for relaying all emission-related service intervals to the final consumer of the product.

For equipment manufacturers who prepare their own warranty cards, owner's manuals, service manuals, operation manuals and any related documents; they must reference the emission-related service intervals and procedures indicated in YANMAR's technical documents: Warranty Statement, Operation Manual, Service Manual and Application Manual.



WARRANTY POLICY

1. Tong yang product Limited Warranty

TYM warrants that each TYM product is free from defects in both material and workmanship, and that TYM will repair or replace, at TYM's sole option, any parts which are determined by TYM to be defective in material or workmanship.

BASIC Warranty: (24 months), (1,000)Hours.

This Limited warranty will cover the period from the date of delivery to the original purchaser from an authorized TYM dealer for a term of **(24 month) or (1,000) operating hours, whichever comes first.**

Coverage

This Limited warranty is limited to TYM repairing or replacing, at TYM's option, warranted parts by an authorized TYM dealer at no charge for either the parts or services. Parts replaced under this Limited Warranty are only warranted for the balance of the warranty period.



WARRANTY

1. TYM shall have no obligation or liability under this warranty.

- (1) for normal maintenance or operation services for Products, including but not limited to, providing lubricants, fuel, tune-up inspection or adjustments.
 - (2) for any consumable parts when such parts are replaced as a part of normal maintenance or operating services.
 - (3) to any exclusions and limitations contained in the Limited Warranty.
2. Options, accessories, attachments installed by Dealers which are not manufactured by TYM will not be warranted in any way by TYM. For information about the warranty or to obtain warranty service on such parts, Dealers should contact the manufacturer directly
3. The Limited Warranty is exclusive and in lieu of all other warranties, whether written, Oral, express or implied, including any warranty of merchantability or fitness for particular purpose.

The liability of TYM under this warranty is expressly limited to the provisions in the Limited Warranty and in no event shall TYM incur any liability(including liability for general, special, incidental or consequential damages, or economic or moral loss, arising out of any failure of the Products) which is not expressly assumed by TYM under this warranty.

